

OpenMS Tutorial

The OpenMS Developers

Mathias Walzer, Timo Sachsenberg, Fabian Aicheler,
Marc Rurik, Johannes Veit,
Bludau Isabell, Patrick Pedrioli,
Julianus Pfeuffer, Xiao Liang,
Knut Reinert, and Oliver Kohlbacher

Creative Commons Attribution 4.0 International (CC BY 4.0)

Contents

1	General remarks	6
2	Getting started	7
2.1	Data conversion	7
2.2	Data visualization using TOPPView	8
2.3	Introduction to KNIME / OpenMS	11
2.3.1	Plugin and dependency installation	11
2.3.2	KNIME concepts	13
2.3.3	Overview of the graphical user interface	14
2.3.4	Creating workflows	16
2.3.5	Sharing workflows	16
2.3.6	Duplicating workflows	17
2.3.7	A minimal workflow	17
2.3.8	Advanced topic: Meta nodes	20
2.3.9	Advanced topic: R integration	21
3	Label-free quantification	23
3.1	Introduction	23
3.2	Peptide Identification	23
3.2.1	Bonus task: identification using several search engines	26
3.3	Quantification	27
3.4	Combining quantitative information across several label-free experiments	29
3.4.1	Basic data analysis in KNIME	31
4	Protein Inference	34
4.1	Extending the LFQ workflow by protein inference and quantification	34
4.2	Statistical validation of protein inference results	36
4.2.1	Data preparation	36
4.2.2	ROC curve of protein ID	36
4.2.3	Posterior probability and FDR of protein IDs	37

5	Metabolomics	39
5.1	Introduction	39
5.2	Quantifying metabolites across several experiments	39
5.3	Identifying metabolites in LC-MS/MS samples	42
5.4	Convert your data into a KNIME table	43
5.4.1	Bonus task: Visualizing data	44
5.5	Downstream data analysis and reporting	45
5.5.1	Data preparation ID	45
5.5.2	Data preparation Quant	45
5.5.3	Statistical analysis	46
5.5.4	Interactive visualization	47
5.5.5	Advanced visualization	48
5.5.6	Data preparation for Reporting	49
6	OpenSWATH	51
6.1	Introduction	51
6.2	Installation of OpenSWATH	51
6.3	Installation of mProphet	51
6.4	Generating the Assay Library	52
6.4.1	Generating TraML from transition lists	52
6.4.2	Appending decoys to a TraML	54
6.5	OpenSWATH KNIME	55
6.6	From the example dataset to real-life applications	56
7	An introduction to pyOpenMS	57
7.1	Introduction	57
7.2	Installation	57
7.2.1	Windows	57
7.2.2	Mac OS X 10.10	57
7.2.3	Linux	58
7.3	Build instructions	58
7.4	Your first pyOpenMS tool: pyOpenSwathFeatureXMLToTSV	58
7.4.1	Basics	59

7.4.2	Loading data structures with pyOpenMS	60
7.4.3	Converting data in the featureXML to a TSV	62
7.4.4	Putting things together	63
7.4.5	Bonus task	64
8	Quality control	65
8.1	Introduction	65
8.2	Building a qcML file per run	66
8.3	Adding brand new QC metrics	69
8.4	Set QC metrics	71
9	Troubleshooting guide	73
9.1	FAQ	73
9.1.1	General	73
9.1.2	Platform-specific problems	73
9.1.3	Nodes	74
9.2	Sources of support	74

1 General remarks

- This handout will guide you through an introductory tutorial for the OpenMS/TOPP software package [1].
- OpenMS [2] is a versatile open-source library for mass spectrometry data analysis. Based on this library, we offer a collection of command-line tools ready to be used by end users. These so-called TOPP tools (short for "The OpenMS Proteomics Pipeline") [3] can be understood as small building blocks of arbitrary complex data analysis workflows.
- In order to facilitate workflow construction, OpenMS was integrated into KNIME [4], the Konstanz Information Miner, an open-source integration platform providing a powerful and flexible workflow system combined with advanced data analytics, visualization, and report capabilities. Raw MS data as well as the results of data processing using TOPP can be visualized using TOPPView [5].
- This tutorial was designed for use in a hands-on tutorial session but can also be worked through at home using the online resources. You will become familiar with some of the basic functionalities of OpenMS/TOPP, TOPPView, and KNIME and learn how to use a selection of TOPP tools used in the tutorial workflows.
- All sample data referenced in this tutorial can be found in the  Example_Data folder on the USB stick that came with this tutorial (or online on our SourceForge).

2 Getting started

Before we get started we will install OpenMS and KNIME using the installers provided on the USB stick. Please choose the directory that matches your operating system and execute the installer. Note that these steps are not necessary if you use one of our laptops.

For example for Windows you call

- the OpenMS installer: `Windows / OpenMS-2.0_Win64_setup.exe`
- the KNIME installer: `Windows / OpenMS-2.0-prerequisites-installer.exe`
and `Windows / KNIME Full 3.1.1 Installer (64bit).exe`

on Mac you call

- the OpenMS installer: `Mac / OpenMS-2.0.0_setup.dmg`
- the KNIME installer: `Mac / knime-full_3.1.1.macosx.cocoa.x86_64.dmg`

and follow the instructions. If you are working through this tutorial at home or downloaded it from our homepage, you can get the installers under the following links:

- OpenMS
- KNIME
- OpenMS prerequisites (Windows-only): After installation, before your first use of the OpenMS plugin in KNIME you will be asked to download it automatically if certain requirements are not found in your Windows registry. Alternatively, you can get a bundled version here.

Choose the installers for the platform you are working on. We suggest to use the full installers of KNIME so that you can skip the installation of the OpenMS plugin and other dependencies for the example workflows.

2.1 Data conversion

Each MS instrument vendor has one or more formats for storing the acquired data. Converting these data into an open format (preferably mzML) is the very first step when you



want to work with open-source mass spectrometry software. A freely available conversion tool is ProteoWizard. The OpenMS installation package for Windows automatically installs ProteoWizard, so you do not need to download and install it separately.

Please note that due to restrictions from the instrument vendors, file format conversion for most formats is only possible on Windows systems, so exporting from the acquisition PC connected to the instrument is usually the most convenient option. All files used in this tutorial have already been converted to mzML by us, so you do not need to do it yourself.

2.2 Data visualization using TOPPView

Visualizing the data is the first step in quality control, an essential tool in understanding the data, and of course an essential step in pipeline development. OpenMS provides a convenient viewer for some of the data: TOPPView.

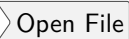
We will guide you through some of the basic features of TOPPView. Please familiarize yourself with the key controls and visualization methods. We will make use of these later throughout the tutorial. Let's start with a first look at one of the files of our tutorial data set:

- Start TOPPView (see Start-Menu or Applications on MacOS)
- Go to  , navigate to the directory where you copied the contents of the USB stick to, and select  Example_Data ▶ Introduction ▶ datasets ▶ small ▶ velos005614.mzML . This file contains a reduced LC-MS map (only a selected RT and m/z range was extracted using the TOPP tool FileFilter) of a label-free measurement of the human platelet proteome recorded on an Orbitrap velos. The other two mzML files contain technical replicates of this experiment. First, we want to obtain a global view on the whole LC-MS map - the default option *Map view 2D* is the correct one and we can click the  button.
- Play around.
- Three basic modes allow you to interact with the displayed data: scrolling, zooming and measuring:

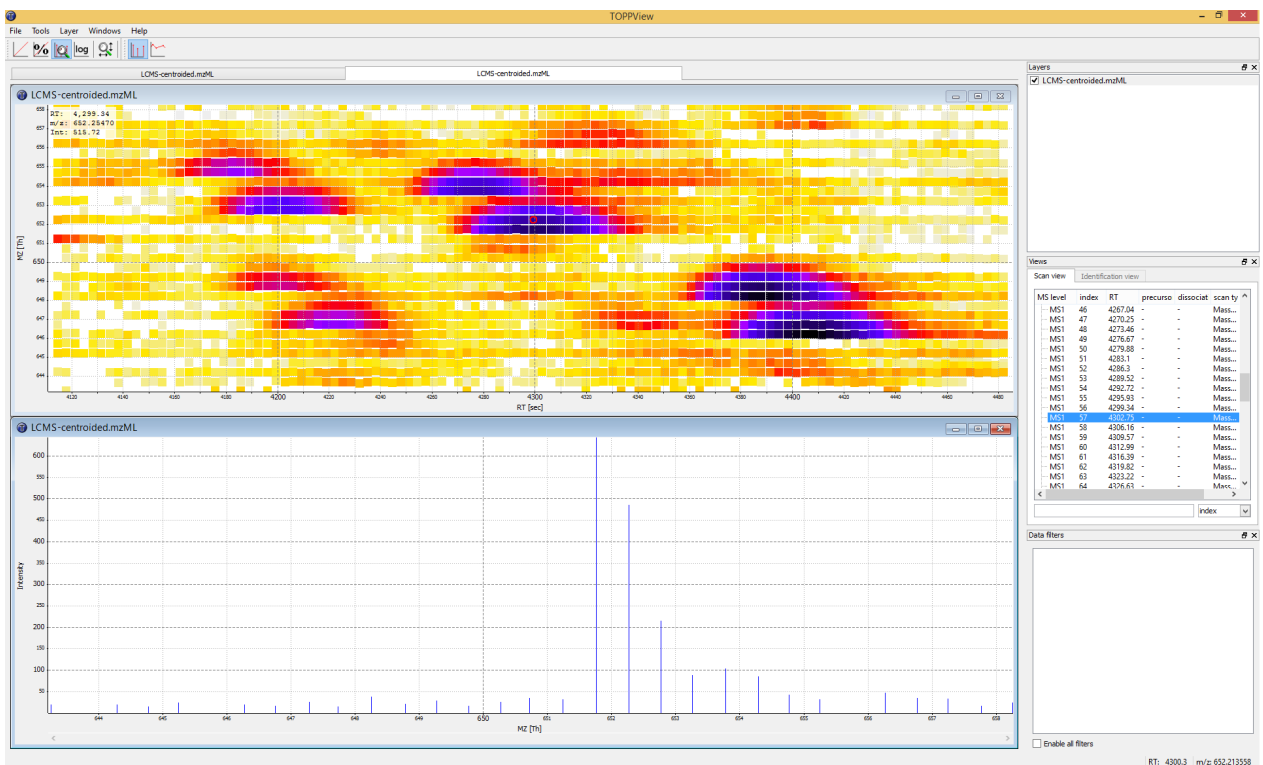

Figure 1: TOPPView, the graphical application for viewing mass spectra and analysis results. Top window shows a small region of a peak map. In this 2D representation of the measured spectra, signals of eluting peptides are colored according to the raw peak intensities. The lower window displays an extracted spectrum (=scan) from the peak map. On the right side, the list of spectra can be browsed.

- Scroll mode
 - * Is activated by default (though each loaded spectra file is displayed zoomed out first, so you do not need to scroll).
 - * Allows you to browse your data by moving around in RT and m/z range.
 - * When zoomed in, to scroll the spectra map, click-drag on the current view.
 - * Arrow keys can be used to scroll the view as well.
- Zoom mode
 - * Zooming into the data: either mark an area in the current view with your mouse while holding the left mouse button plus the `ctrl` key to zoom to this area or use your mouse wheel to zoom in and out.
 - * All previous zoom levels are stored in a zoom history. The zoom history can be traversed using `ctrl + +` or `ctrl + -` or the mouse wheel (scroll up and down).
 - * Pressing the Backspace key zooms out to show the full LC-MS map (and also resets the zoom history).
- Measure mode
 - * It is activated using the `↑` key.
 - * Press the left mouse button down while a peak is selected and drag the mouse to another peak to measure the distance between peaks.
 - * This mode is implemented in the 1D and 2D mode only.
- Right click on your 2D map and select `Switch to 3D view` and examine your data in 3D mode
- Go back to the 2D view. In 2D mode, visualize your data in different normalization modes, use linear, percentage and log-view (icons on the upper left tool bar).

Note: On *Apple OS X*, due to a bug in one of the external libraries used by OpenMS, you will see a small window of the 3D mode when switching to 2D. Close the 3D tab in order to get rid of it.
- In TOPPView you can also execute TOPP tools. Go to `Tools >> Apply tool (whole layer)` and choose a TOPP tool (e.g., FileInfo) and inspect the results.

2.3 Introduction to KNIME / OpenMS

Using OpenMS in combination with KNIME you can create, edit, open, save, and run workflows combining TOPP tools with the powerful data analysis capabilities of KNIME. Workflows can be created conveniently in a graphical user interface. The parameters of all involved tools can be edited within the application and are also saved as part of the workflow. Furthermore, KNIME interactively performs validity checks during the workflow editing process, in order to make it more difficult to create an invalid workflow.



Throughout most of the parts of this tutorial you will use KNIME to create and execute workflows. This first step is to make yourself familiar with KNIME. Additional information on basic usage of KNIME can be found on the KNIME Getting Started page. However, the most important concepts will also be reviewed in this tutorial.

2.3.1 Plugin and dependency installation

Note: If you installed the binaries from our USB Stick or downloaded and installed the full release of KNIME with all contributing plugins, you can skip this section.

Before we can start with the tutorial we need to install all the required extensions for KNIME.

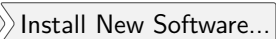
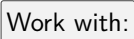
First, we install some additional extensions that are required by our OpenMS nodes or used in the Tutorials e.g. for visualization and file handling.

1. Click on  
2. From the  drop down list select 
3. Now select the following plugins from the *KNIME & Extensions* category
 - KNIME Base Chemistry Types & Nodes
 - KNIME Chemistry Add-Ons
 - KNIME File Handling Nodes (required for OpenMS nodes in general)
 - KNIME Interactive R Statistics Integration
 - KNIME R Statistics Integration (Windows Binaries)

- KNIME Report Designer
- KNIME SVG Support
- KNIME XLS Support
- KNIME XML-Processing
- (Older versions of KNIME do not have KNIME Math Expression (JEP) installed which is used in one of the workflows)

4. From the **Work with:** drop down list select

<http://tech.knime.org/update/community-contributions/trusted/3.1>

5. Now select the following plugin from the "KNIME Community Contributions - Cheminformatics" category

- RDKit KNIME integration

6. Follow the instructions and after a restart of KNIME the dependencies will be installed.

You are now ready to install the OpenMS nodes.

1. Open KNIME.

2. Click on **Help** >> **Install New Software...**

3. From the **Work with:** drop down list select the

<http://tech.knime.org/update/community-contributions/trusted/3.1>

4. Select the **OpenMS** nodes in the category:

"KNIME Community Contributions - Bioinformatics & NGS" and click **Next**.

5. Follow the instructions and after a restart of KNIME the OpenMS nodes will be available under "Community Nodes".

2.3.2 KNIME concepts

A **workflow** is a sequence of computational steps applied to a single or multiple input data sets to process and analyze the data. In KNIME such workflows are implemented graphically by connecting so-called **nodes**. A node represents a single analysis step in a workflow. Nodes have input and output **ports** where the data enters the node or the results are provided for other nodes after processing, respectively. KNIME distinguishes between different port types, representing different types of data. The most common representation of data in KNIME are tables (similar to an excel sheet). Ports that accept tables are marked with a small triangle. For OpenMS we use a different port type, so called **file ports**, representing complete files. Those ports are marked by a small blue box. Filled blue boxes represent mandatory inputs and empty blue boxes optional inputs. A typical OpenMS workflow in KNIME can be divided in two conceptually different parts:

- Nodes for signal and data processing, filtering and data reduction. Here, files are passed between nodes. Execution times of the individual steps are longer as the main computational steps are performed.
- Downstream statistical analysis and visualization. Here, tables are passed between nodes.

Between file-based processing and table-based analysis a conversion node typically performs the conversion from OpenMS results into KNIME tables. Nodes can have three different states, indicated by the small traffic light below the node.

- Inactive, failed, and not yet fully configured nodes are marked red.
- Configured but not yet executed nodes are marked yellow.
- Successfully executed nodes are marked green.

If the node execution failed the node will switch to the red state. Other anomalies and warnings like missing information or empty results will be presented with a yellow exclamation mark sign above the traffic light. Most nodes will be configured as soon as all input ports are connected. For some nodes additional parameters have to be provided that cannot be either guessed from the data or filled with sensible defaults. In this case,

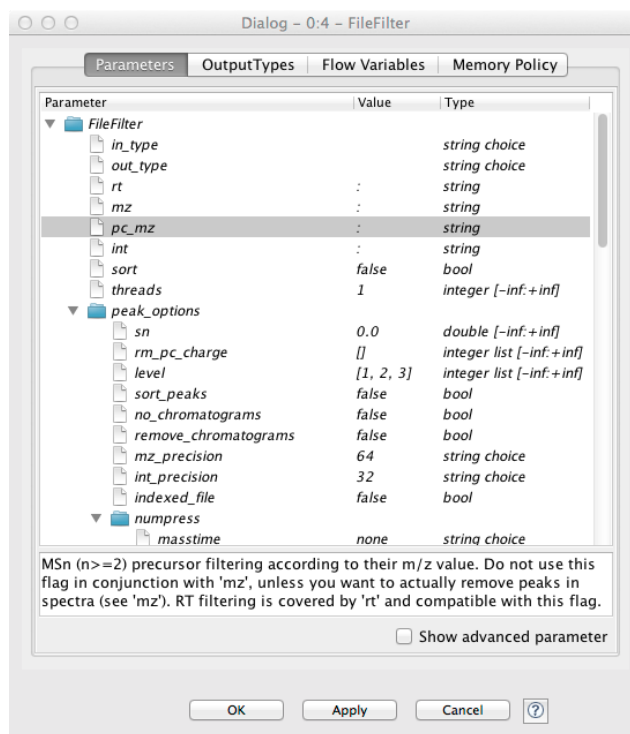

Figure 2: Node configuration dialog of an OpenMS node.

of if you want to customize the default configuration, you can open the configuration dialog of a node with a double-click on the node. For all OpenMS nodes you will see a configuration dialog like the one shown in Figure 2.

Note: OpenMS distinguishes between normal parameters and advanced parameters. Advanced parameters are by default hidden from the users since they should only rarely be customized. In case you want to have a look at the parameters or need to customize them in one of the tutorials you can show them by clicking on the checkbox Show advanced parameter in the lower part of the dialog.

The dialog shows the individual parameters, their current value and type, and, in the lower part of the dialog, the documentation for the currently selected parameter.

2.3.3 Overview of the graphical user interface

The graphical user interface (GUI) of KNIME consists of different components or so called panels that are shown in Figure 3. We will shortly introduce the individual panels and their

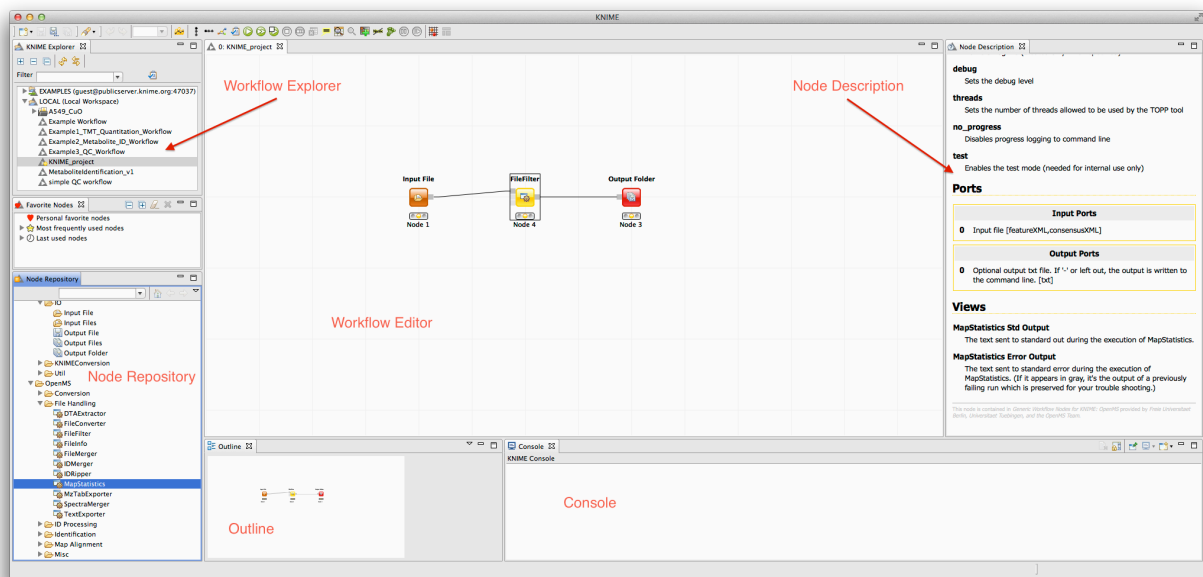

Figure 3: The KNIME workbench.

purposes below.

Workflow Editor: The workflow editor is the central part of the KNIME GUI. Here you assemble the workflow by adding nodes from the Node Repository via "drag & drop". For quick creation note that double-clicking on a node in the repository automatically connects it with the selected node in the workbench. Nodes can be connected by clicking on the output port of one node and dragging the edge until releasing the mouse at the desired input port of the next node.

Workflow Explorer: Shows a list of available workflows (also called workflow projects). You can open a workflow by double clicking it. A new workflow can be created with a right-click in the Workflow Explorer followed by selecting `New KNIME Workflow...`. Remember to save your workflow often with the Ctrl+S shortcut.

Node Repository: Shows all nodes that are available in your KNIME installation. Every plugin you install will provide new nodes that can be found here. The OpenMS nodes can be found in `Community Nodes >> OpenMS`. Nodes for managing files (e.g., Input Files or Output Folders) can be found in `Community Nodes >> GenericKnodeNodes`. You

can search the node repository by typing the node name into the small text box in the upper part of the node repository.

Outline: The Outline panel contains a small overview of the complete workflow. While of limited use when working on a small workflow, this feature is very helpful as soon as the workflows get bigger.



Console: In the console panel warning and error messages are shown. This panel will provide helpful information if one of the nodes failed or shows a warning sign.

Node Description: As soon as a node is selected, the Node Description window will show the documentation of the node including documentation for all its parameters. For OpenMS nodes you will also find a link to the tool page in the online documentation.

2.3.4 Creating workflows

Workflows can easily be created by a right click in the Workflow Explorer followed by clicking on .

2.3.5 Sharing workflows

To be able to share a workflow with others, KNIME supports the import and export of complete workflows. To export a workflow, select it in the Workflow Explorer and select . KNIME will export workflows as a zip file containing all the information on nodes, their connections, and their configuration. Those zip files can again be imported by selecting .

Note: For your convenience we added all workflows discussed in this tutorial to the  workflows folder on the USB Stick. Additionally the zip files can be found on our GitHub repository. If you want to check your own workflow by comparing it to the solution or got stuck, simply import the full workflow from the corresponding zip file.

2.3.6 Duplicating workflows

During the tutorial a lot of the workflows will be created based on the workflow from a previous task. To keep the intermediate workflows we suggest you create copies of your workflows so you can see the progress. To create a copy of your workflow follow the next steps.

- Right click on the workflow you want to create a copy of in the Workflow Explorer and select `Copy`.
- Right click again somewhere on the workflow explorer and select `Paste`.
- This will create a workflow with same name as the one you copied with a (2) appended.
- To distinguish them later on you can easily rename the workflows in the Workflow Explorer by right clicking on the workflow and selecting `Rename`.

Note: To rename a workflow it has to be closed.

2.3.7 A minimal workflow

Let us now start with the creation of our very first, very simple workflow. As a first step, we will gather some basic information about the data set before starting the actual development of a data analysis workflow.

- Create a new workflow.
- Add an Input File node and an Output Folder node (to be found in `Community Nodes` `GenericKnimeNodes` `IO`) and a FileInfo node (to be found in the category `Community Nodes` `OpenMS` `File Handling`) to the workflow.
- Connect the Input File node to the FileInfo node, and the first output port of the FileInfo node to the Output Folder node.

Note: In case you are unsure about which node port to use, hovering the cursor over the port in question will display the port name and what kind of input it expects.

The complete workflow is shown in Figure 4. FileInfo can produce two different kinds of output files.

- All nodes are still marked red, since we are missing an actual input file. Double-click the Input File node and select . In the file system browser select ▶ Introduction ▶ datasets ▶ tiny ▶ velos005614.mzML and click . Afterwards close the dialog by clicking .

Note: Make sure to use the ``tiny'' version this time, not ``small'', for the sake of faster workflow execution.

- The Input File node and the FileInfo node should now have switched to yellow, but the Output Folder node is still red. Double-click on the Output Folder node and click on to select an output directory for the generated data.
- Great! Your first workflow is now ready to be run. Press + to execute the complete workflow. You can also right click on any node of your workflow and select from the context menu.
- The traffic lights tell you about the current status of all nodes in your workflow. Currently running tools show either a progress in percent or a moving blue bar, nodes waiting for data show the small word ``queued'', and successfully executed ones become green. If something goes wrong (e.g., a tool crashes), the light will become red.
- In order to inspect the results, you can just right-click the Output Folder node and select . You can then open the text file and inspect its contents. You will find some basic information of the data contained in the mzML file, e.g., the total number of spectra and peaks, the RT and m/z range, and how many MS1 and MS2 spectra the file contains.



Figure 4: A minimal workflow calling FileInfo on a single file.

Workflows are typically constructed to process a large number of files automatically. As a simple example, consider you would like to gather this information for more than one file. We will now modify the workflow to compute the same information on three different files and then write the output files to a folder.

- We start from the previous workflow.
- First we need to replace our single input file with multiple files. Therefore we add the Input Files node from the category `Community Nodes > GenericKnlmeNodes > IO`.
- To select the files we double-click on the Input Files node and click on `Add`. In the filesystem browser we select all three files from the directory `Example_Data > Introduction > datasets > tiny`. And close the dialog with `Ok`.
- We now add two more nodes: the ZipLoopStart and the ZipLoopEnd node from the category `Community Nodes > GenericKnlmeNodes > Flow`.
- Afterwards we connect the Input Files node to the first port of the ZipLoopStart node, the first port of the ZipLoopStart node to the FileInfo node, the first output port of the FileInfo node to the first input port of the ZipLoopEnd node, and the first output port of the ZipLoopEnd node to the Output Folder node (NOT to the Output File). The complete workflow is shown in Figure 5
- The workflow is already complete. Simply execute the workflow and inspect the output as before.

In case you had trouble to understand what ZipLoopStart and ZipLoopEnd do - here is a brief explanation:

- The Input Files node passes a list of files to the ZipLoopStart node.



Figure 5: A minimal workflow calling FileInfo on multiple files in a loop.

- The ZipLoopStart node takes the files as input, but passes the single files sequentially (that is: one after the other) to the next node.
- The ZipLoopEnd collects the single files that arrive at its input port. After all files have been processed, the collected files are passed again as file list to the next node that follows.

2.3.8 Advanced topic: Meta nodes

Workflows can get rather complex and may contain dozens or even hundreds of nodes. KNIME provides a simple way to improve handling and clarity of large workflows:

Meta Nodes allow to bundle several nodes into a single Meta Node.

Task



Select multiple nodes (e.g. all nodes of the ZipLoop including the start and end node). To select a set of nodes, draw a rectangle around them with the left mouse button or hold **Ctrl** to add/remove single nodes from the selection. Open the context menu (right-click on a node in the selection) and select **Collapse into Meta Node**. Enter a caption for the Meta Node. The previously selected nodes are now contained in the Meta Node. Double clicking on the Meta Node will display the contained nodes in a new tab window.

Task



Undo the packaging. First select the Meta Node, open the context menu (right-click) and select **Expand Meta Node**.

2.3.9 Advanced topic: R integration

KNIME provides a large number of nodes for a wide range of statistical analysis, machine learning, data processing and visualization. Still, more recent statistical analysis methods, specialized visualizations or cutting edge algorithms may not be covered in KNIME. In order to expand its capabilities beyond the readily available nodes, external scripting languages can be integrated. In this tutorial, we primarily use scripts of the powerful statistical computing language R. Note that this part is considered advanced and might be difficult to follow if you are not familiar with R. In this case you might skip this part.

R View (Table) allows to seamlessly include R scripts into KNIME. We will demonstrate on a minimal example how such a script is integrated.

Task



First we need some example data in KNIME, which we will generate using the Data Generator node. You can keep the default settings and execute the node. The table contains 4 columns, each containing random coordinates and one column containing a cluster number (Cluster_0 to Cluster_3). Now place a R View (Table) node into the workflow and connect the upper output port of the Data Generator node to the input of the R View (Table) node. Right-click and configure the node.

If you get an error message like "Execute failed: R_HOME does not contain a folder with name 'bin'.": please change the R settings in the preferences. To do so open **File > Preferences > KNIME > R** and enter the path to your R installation (the folder that contains the bin directory).

If R is correctly recognized we can start writing an R script. Consider that we are interested in plotting the first and second coordinates and color them according to their cluster number. In R this can be done in a single line.

In the R View (Table) text editor, enter the following code:

```
plot(x=knime.in$Universe_0_0, y=knime.in$Universe_0_1, main="Plotting column ←  
Universe_0_0 vs. Universe_0_1", col=knime.in$"Cluster Membership")
```

Explanation: The table provided as input to the R View (Table) node

is available as R `data.frame` with name `knime.in`. Columns (also listed on the left side of the R View window) can be accessed in the usual R way by first specifying the `data.frame` name and then the column name (e.g. `knime.in$Universe_0_0`). `plot` is the plotting function we use to generate the image. We tell it to use the data in column `Universe_0_0` of the dataframe object `knime.in` (denoted as `knime.in$Universe_0_1`) as x-coordinate and the other column `knime.in$Universe_0_1` as y-coordinate in the plot. `main` is simply the main title of the plot and `col` the column that is used to determine the color (in this case it is the `Cluster Membership` column).

Now press the `Eval script` and `Show plot` buttons.

Note: Note that we needed to put some extra quotes around `Cluster Membership`. If we omit those, R would interpret the column name only up to the first space (`knime.in$Cluster`) which is not present in the table and leads to an error. Quotes are regularly needed if column names contain spaces, tabs or other special characters like `$` itself.

3 Label-free quantification

3.1 Introduction

In this chapter, we will build a workflow with OpenMS / KNIME to quantify a label-free experiment. Label-free quantification is a method aiming to compare the relative amounts of proteins or peptides in two or more samples. We will start from the minimal workflow of the last chapter and, step-by-step, build a label-free quantitation workflow.

3.2 Peptide Identification

As a start, we will extend the minimal workflow so that it performs a peptide identification using the OMSSA [6] search engine. Since OpenMS version 1.10, OMSSA is included in the OpenMS installation, so you do not need to download and install it yourself.

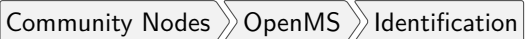
- Let's start by replacing the input files in our `Input Files` node by the three mzML files in `Example_Data > Labelfree > datasets > lfq_spikein_dilution_1-3.mzML`. This is a reduced toy dataset where each of the three runs contains a constant background of *S. pyogenes* peptides as well as human spike-in peptides in different concentrations. [7]
- Instead of `FileInfo`, we want to perform OMSSA identification, so we simply replace the `FileInfo` node with the OMSSAAdapter node , and we are almost done. Just make sure you have connected the `ZipLoopStart` node with the `in` port of the OMSSAAdapter node.
- OMSSA, like most mass spectrometry identification engines, relies on searching the input spectra against sequence databases. Thus, we need to introduce a search database input. As we want to use the same search database for all of our input files, we can just add a single `Input File` node to the workflow and connect it directly with the OMSSAAdapter database port. KNIME will automatically reuse this `Input` node each time a new `ZipLoop` iteration is started. In order to specify the database, select `Example_Data > Labelfree > databases > s_py0_sf370_potato_human_target_decoy_with_contaminants.fasta`, and we have a very basic peptide identification workflow.

Note: You might also want to save your new identification workflow under a different name. Have a look at Section 2.3.6 for information on how to create copies of workflows.

- The result of a single OMSSA run is basically a number of peptide-spectrum-matches (PSM) with a score each, and these will be stored in an idXML file. Now we can run the pipeline and after execution is finished, we can have a first look at the results: just open the input files folder with a file browser and from there open an mzML file in TOPPView.
- Here, you can annotate this spectrum data file with the peptide identification results. Choose **Tools** > **Annotate with identification** from the menu and select the idXML file that OMSSAAdapter generated (it is located within the output directory that you specified when starting the pipeline).
- On the right, select the tab **Identification view**. Using this view, you can see all identified peptides and browse the corresponding MS2 spectra.

Note: Opening the output file of OMSSAAdapter (the idXML file) directly is also possible, but the direct visualization of an idXML file is less useful.

- The search results stored in the idXML file can also be read back into a KNIME table for inspection and subsequent analyses: Add a TextExporter **Community Nodes** > **OpenMS** > **File Handling** node to your workflow and connect the output port of your OMSSAAdapter (the same port your ZipLoopEnd is connected to) to its input port. This tool will convert the idXML file to a more human-readable text file which can also be read into a KNIME table using the IDTextReader node. Add an IDTextReader node **Community Nodes** > **OpenMS** > **Conversion** after TextExporter and execute it. Now you can right-click IDTextReader and select **ID Table** to browse your peptide identifications.
- From here, you can use all the tools KNIME offers for analyzing the data in this table. As a simple example, you could add a Histogram **Data Views** node after IDTextReader, double-click it, select *peptide_charge* as binning column, hit **OK**, and execute it. Right-clicking and selecting **View: Histogram view** will open a plot showing the charge state distribution of your identifications.

In the next step, we will tweak the parameters of OMSSA to better reflect the instrument's accuracy. Also, we will extend our pipeline with a false discovery rate (FDR) filter to retain only those identifications that will yield an FDR of $< 1\%$.

- Open the configuration dialog of OMSSAAdapter. The dataset was recorded using an LTQ Orbitrap XL mass spectrometer, so we can set the precursor mass tolerance to a smaller value, say 10 ppm. Set *precursor_mass_tolerance* to 10 and *precursor_mass_tolerance_unit_ppm* to *true*.

Note: Whenever you change the configuration of a node, the node as well as all its successors will be reset to the Configured state.

- Set *max_precursor_charge* to 5, in order to also search for peptides with charges up to 5.
- Add Carbamidomethyl (C) as fixed modification and Oxidation (M) as variable modification.

Note: To add a modification click on the empty value field in the configuration dialog to open the list editor dialog. In the new dialog click . Then select the newly added modification to open the drop down list where you can select the correct modification.

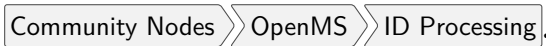
- A common step in analysis is to search not only against a regular protein database, but to also search against a decoy database for FDR estimation. The fasta file we used before already contains such a decoy database. For OpenMS to know which OMSSA PSM came from which part of the file (i.e. target versus decoy), we have to index the results. Therefore extend the workflow with a PeptideIndexer node . This node needs the idXML as input as well as the database file.

Note: You can direct the files of an Input File node to more than just one destination port.

- The decoys in the database are prefixed with ``REV_``, so we have to set *decoy_string* to *REV_* and *prefix* to *true* in the configuration dialog of PeptideIndexer.

- Now we can go for the FDR estimation, which the `FalseDiscoveryRate` node will calculate for us `Community Nodes` `OpenMS` `ID Processing`. As we have a combined search database and thus only one `idXML` per `mzML` we will only use the `in` port of the `FalseDiscoveryRate` node.
- In order to set the FDR level to 1%, we need an `IDFilter` node from `Community Nodes` `OpenMS` `ID Processing`. Configuring its parameter `score` \rightarrow `pep` to 0.01 will do the trick. The FDR calculations (embedded in the `idXML`) from the `FalseDiscoveryRate` node will go into the `in` port of the `IDFilter` node.
- Execute your workflow and inspect the results using `IDTextReader` like you did before. How many peptides did you identify at this FDR threshold?

Note: The finished identification workflow is now sufficiently complex that we might want to encapsulate it in a Meta node. For this, select all nodes inside the `ZipLoop` (including the `Input File` node) and right-click to select `Collapse into Meta node` and name it `ID`. Meta nodes are useful when you construct even larger workflows and want to keep an overview.

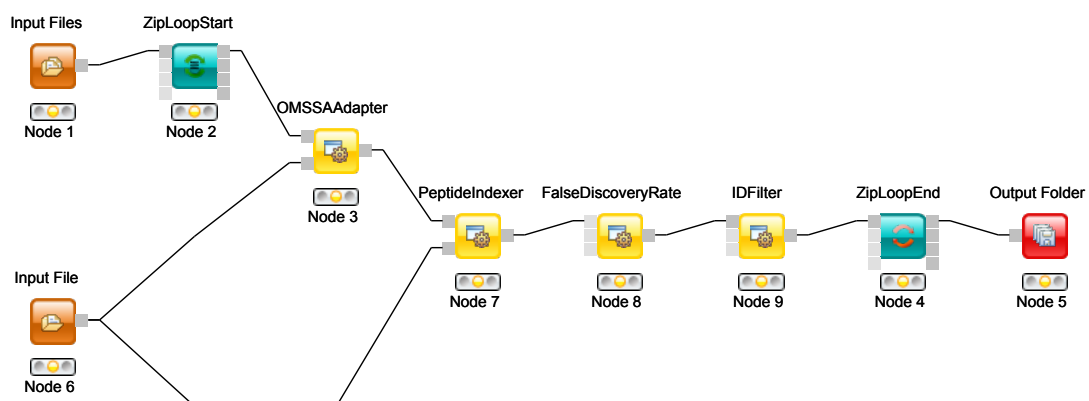
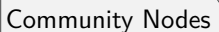
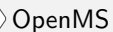
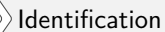
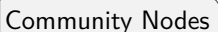





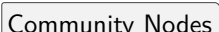

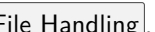

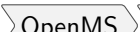



Figure 6: OMSSA ID pipeline including FDR filtering.

3.2.1 Bonus task: identification using several search engines

Note: If you are ahead of the tutorial or later on, you can further improve your FDR identification workflow by a so-called consensus identification using several search engines. Otherwise, just continue with section 3.3.

It has become widely accepted that the parallel usage of different search engines can increase peptide identification rates in shotgun proteomics experiments. The ConsensusID algorithm is based on the calculation of posterior error probabilities (PEP) and a combination of the normalized scores by considering missing peptide sequences.

- Next to the OMSSAAdapter add a XTandemAdapter    node and set its parameters and ports analogously to the OMSSAAdapter.
- To calculate the PEP, introduce each a IDPosteriorErrorProbability    node to the output of each ID engine adapter node. This will calculate the PEP to each hit and output an updated idXML.
- To create a consensus, we must first merge these two files with a FileMerger node    so we can then merge the corresponding IDs with a IDMerger   .
- Now we can create a consensus identification with the ConsensusID    node. We can connect this to the PeptideIndexer and go along with our existing FDR filtering.

Note: By default, X!Tandem takes additional enzyme cutting rules into consideration (besides the specified tryptic digest). Thus you have to set PeptideIndexer's *enzyme* → *specificity* parameter to *semi* to accept X!Tandem's semi tryptic identifications as well.

3.3 Quantification

Now that we have successfully constructed a peptide identification pipeline, we can add quantification capabilities to our workflow.

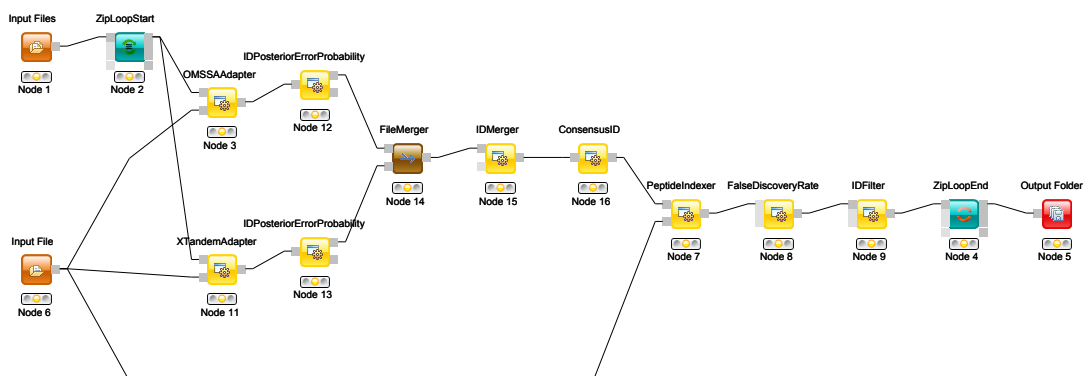

Figure 7: Complete consensus identification workflow.

- Add a FeatureFinderCentroided node Community Nodes OpenMS Quantitation which gets input from the first output port of the ZipLoopStart node. Also, add an IDMapper node Community Nodes OpenMS ID Processing which gets input from the FeatureFinderCentroided node and the ID Meta node (or IDFilter node if you haven't used the Meta node). The output of the IDMapper is then connected to the ZipLoopEnd node.
- FeatureFinderCentroided finds and quantifies peptide ion signals contained in the MS1 data. It reduces the entire signal, i.e., all peaks explained by one and the same peptide ion signal, to a single peak at the maximum of the chromatographic elution profile of the monoisotopic mass trace of this peptide ion and assigns an overall intensity.
- FeatureFinderCentroided produces a featureXML file as output, containing only quantitative information of so-far unidentified peptide signals. In order to annotate these with the corresponding ID information, we need the IDMapper node.
- Run your pipeline and inspect the results of the IDMapper node in TOPPView.
- In order to assess how well the feature finding worked, you can project the features contained in the featureXML file on the raw data contained in the mzML file. In TOPPView choose File Open file and select the mzML file corresponding to your featureXML file in Example_Data Labelfree datasets. In the dialog that pops up, select Open in New layer. Zoom in until you see boxes (found features) around the peptide signals in the raw data.

Note: The RT range is very narrow. Thus, select the full RT range and zoom only into the m/z dimension by holding down CTRL (CMD on Mac) and repeatedly dragging a narrow box from the very left to the very right.

- You can see which features were annotated with a peptide identification by first selecting the featureXML file in the Layers window on the upper right side and then clicking on the icon with the letters A, B and C on the upper icon bar. Now, click on the small triangle next to that icon and select Peptide identification.

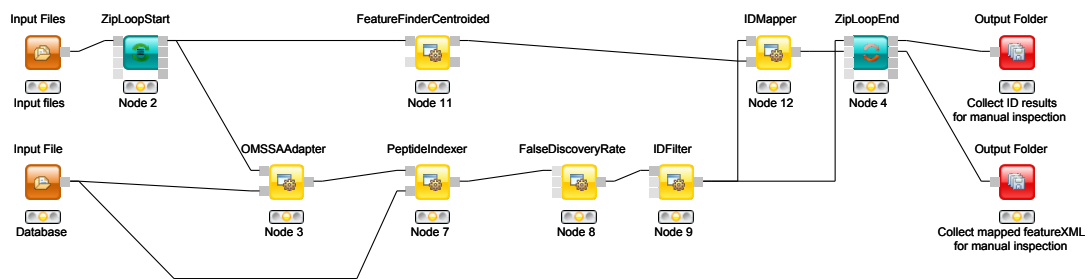

Figure 8: Extended workflow featuring peptide identification and quantification.

3.4 Combining quantitative information across several label-free experiments

So far, we successfully performed peptide identification as well as quantification on individual LC-MS runs. For differential label-free analyses, however, we need to identify and quantify corresponding signals in different experiments and link them together to compare their intensities. Thus, we will now run our pipeline on all three available input files and extend it a bit further, so that it is able to find and link features across several runs.

- To find features across several maps, we first have to align them to correct for retention time shifts between the different label-free measurements. With the `MapAlignerPoseClustering` `Community Nodes` `OpenMS` `Map Alignment`, we can align corresponding peptide signals to each other as closely as possible by applying a transformation in the RT dimension.

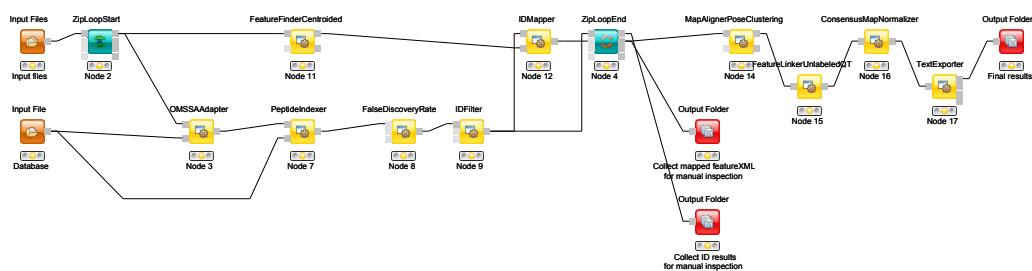

Figure 9: Complete identification and label-free quantification workflow.

Note: MapAlignerPoseClustering consumes several featureXML files and its output should still be several featureXML files containing the same features, but with the transformed RT values. In its configuration dialog, make sure that *OutputTypes* is set to featureXML.

- With the FeatureLinkerUnlabeledQT node Community Nodes OpenMS Map Alignment, we can then perform the actual linking of corresponding features. Its output is a consensusXML file containing linked groups of corresponding features across the different experiments.
- Since the overall intensities can vary a lot between different measurements (for example, because the amount of injected analytes was different), we apply the ConsensusMapNormalizer Community Nodes OpenMS Map Alignment as a last processing step. Configure its parameters with setting *algorithm_type* to median. It will then normalize the maps in such a way that the median intensity of all input maps is equal.
- Finally, we export the resulting normalized consensusXML file to a csv format using TextExporter. Connect its out port to a new Output Folder node.

Note: You can specify the desired column separation character in the parameter settings (by default, it is set to ` ` (a space)). The output file of TextExporter can also be opened with external tools, e.g., Microsoft Excel, for downstream statistical analyses.

3.4.1 Basic data analysis in KNIME

For downstream analysis of the quantification results within the KNIME environment, you can use the `ConsensusTextReader` node (Community Nodes >> OpenMS >> Conversion) instead of the `Output Folder` node to convert the output into a KNIME table (indicated by a triangle as output port). After running the node you can view the KNIME table by right clicking on the `ConsensusTextReader` and selecting `Consensus Table`. Every row in this table corresponds to a so-called consensus feature, i.e., a peptide signal quantified across several runs. The first couple of columns describe the consensus feature as a whole (average RT and m/z across the maps, charge, etc.). The remaining columns describe the exact positions and intensities of the quantified features separately for all input samples (e.g., `intensity_0` is the intensity of the feature in the first input file). The last 11 columns contain information on peptide identification.

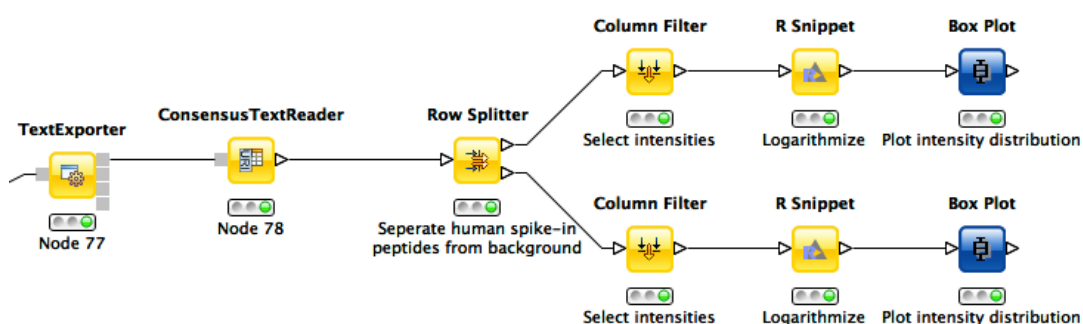

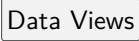

Figure 10: Simple KNIME data analysis example for LFQ.

- Now, let's say we want to plot the log intensity distributions of the human spike-in peptides for all input files. In addition, we will plot the intensity distributions of the background peptides.
- As shown in Fig. 10, add a `Row Splitter` node (Data Manipulation >> Row >> Filter) after `ConsensusTextReader`. Double-click it to configure. The human spike-in peptides have accessions starting with ```hum```. Thus, set the column to test to `accessions`, select pattern matching as matching criterion, enter `hum*` into the corresponding text field, and check the `contains wild cards` box. Press OK and execute the node.



- Row Splitter produces two output tables: the first one contains all rows from the input table matching the filter criterion, and the second table contains all other rows. You can inspect the tables by right-clicking and selecting *Filtered* and *Filtered Out*. The former table should now contain only peptides with a human accession, whereas the latter should contain all remaining peptides (including unidentified ones).
- Now, since we only want to plot intensities, we can add a Column Filter node , connect its input port to the *Filtered* output port of the Row Filter, and open its configuration dialog. We could either manually select the columns we want to keep, or, more elegantly, select *Wildcard/Regex Selection* and enter *intensity_?* as the pattern. KNIME will interactively show you which columns your pattern applies to while you're typing.
- Since we want to plot log intensities, we will now compute the log of all intensity values in our table. The easiest way to do this in KNIME is a small piece of R code. Add an R Snippet node  after Column Filter and double-click to configure. In the *R Script* text editor, enter the following code:

```
x <- knime.in      # store copy of input table in x
x[x == 0] <- NA    # replace all zeros by NA (= missing value)
x <- log10(x)      # compute log of all values
knime.out <- x     # write result to output table
```

- Now we are ready to plot! Add a Box Plot node  after the R Snippet node, execute it, and open its view. If everything went well, you should see a significant fold change of your human peptide intensities across the three runs.
- In order to verify that the concentration of background peptides is constant in all three runs, you can just copy and paste the three nodes after Row Splitter and connect the duplicated Column Filter to the second output port (*Filtered Out*) of Row Splitter, as shown in Fig. 10. Execute and open the view of your second Box Plot.
- That's it! You have constructed an entire identification and label-free quantification workflow including a simple data analysis using KNIME!

Note: For further inspiration you might want to take a look at the more advanced KNIME data analysis examples in the metabolomics tutorial.

4 Protein Inference

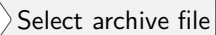
In the last chapter, we have successfully quantified peptides in a label-free experiment. As a next step, we will further extend this label-free quantification workflow by protein inference and protein quantification capabilities. This workflow uses some of the more advanced concepts of KNIME, as well as a few more nodes containing R code. For these reasons, you will not have to build it yourself. Instead, we have already prepared and copied this workflow to the USB sticks. Just import  Workflows > Protein Inference > protein_inference.zip into KNIME via  File >>  Import KNIME workflow >>  Select archive file and double-click the imported workflow in order to open it.

Before you can execute the workflow, you again have to correct the locations of the files in the Input Files nodes (don't forget the one for the FASTA database inside the ``ID" meta node). Try and run your workflow.

4.1 Extending the LFQ workflow by protein inference and quantification

We have made the following changes compared to the original label-free quantification workflow from the last chapter:

- First, we have added a ProteinQuantifier node and connected its input port to the output port of ConsensusMapNormalizer.
- This already enables protein quantification. ProteinQuantifier quantifies peptides by summarizing over all observed charge states and proteins by summarizing over their quantified peptides. It stores two output files, one for the quantified peptides and one for the proteins.
- In this example, we consider only the protein quantification output file, which is written to the first output port of ProteinQuantifier
- Because there is no dedicated node in KNIME to read back the ProteinQuantifier output file format into a KNIME table, we have to use a workaround. Here, we have added an additional URI Port to Variable node which converts the name of the output file to a so-called ``flow variable" in KNIME. This variable is passed on to the

next node CSV Reader, where it is used to specify the name of the input file to be read. If you double-click on CSV Reader, you will see that the text field, where you usually enter the location of the CSV file to be read, is greyed out. Instead, the flow variable is used to specify the location, as indicated by the small green button with the ``v=?" label on the right.

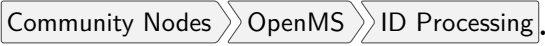
- The table containing the ProteinQuantifier results is filtered one more time in order to remove decoy proteins. You can have a look at the final list of quantified protein groups by right-clicking the Row Filter and selecting .
- By default, i.e., when the second input port *protein_groups* is not used, ProteinQuantifier quantifies proteins using only the unique peptides, which usually results in rather low numbers of quantified proteins.
- In this example, however, we have performed protein inference using Fido and used the resulting protein grouping information to also quantify indistinguishable proteins
- As a prerequisite for using FidoAdapter, we have added an IDPosteriorErrorProbability node within the ID meta node, between OMSSAAdapter and PeptideIndexer. We have set its parameter *prob_correct* to *true*, so it computes posterior probabilities instead of posterior error probabilities (1 - PEP). These are stored in the resulting idXML file and later on used by the Fido algorithm.
- Next, we have added a third outgoing connection to our ID meta node and connected it to the second input port of ZipLoopEnd. Thus, KNIME will wait until all input files have been processed by the loop and then pass on the resulting list of idXML files to the subsequent IDMerger node, which merges all identifications from all idXML files into a single idXML file.
- Instead of the meta node Protein inference with FidoAdapter, we could have just used a FidoAdapter node . However, the meta node contains an additional subworkflow which, besides calling FidoAdapter, performs a statistical validation of the protein inference results using some of the more advanced KNIME nodes.

4.2 Statistical validation of protein inference results

In the following, we will explain the subworkflow contained in the Protein inference with FidoAdapter meta node.

4.2.1 Data preparation

For downstream analysis on the protein ID level in KNIME, it is again necessary to convert the idXML-file-format result generated from FidoAdapter into a KNIME table.

- By setting *proteins_only* to true in TextExporter, only the protein IDs are exported.
- As the built-in table file reader IDTextReader only reads peptide hits, we have to use URI Port to Variable which collects the URIs from a URI port object and puts them into variables.
- However, doing this will cause missing column information in the converted KNIME table. Open the File Viewer and check what each column stands for, filter away unused columns, such as sequence, coverage and rank in the Column Filter node. Add the column names manually in Column Rename.

4.2.2 ROC curve of protein ID

ROC Curves (Receiver Operating Characteristic curves) are graphical plots that visualize sensitivity (true-positive rate) against fall-out (false positive rate). They are often used to judge the quality of a discrimination method like e.g., peptide or protein identification engines. ROC Curve already provides the functionality of drawing ROC curves for binary classification problems. Before applying this node, an extra column with the class values (target and decoy proteins) has to be appended in the Rule engine node.

In protein or peptide identification, the ground-truth (i.e., which target identifications are true, which are false) is usually not known. Instead, so called pseudo-ROC Curves are regularly used to plot the number of target proteins against the false discovery rate (FDR). The FDR is approximated by using the target-decoy estimate in order to distinguish true IDs from false IDs by separating target IDs from decoy IDs.

4.2.3 Posterior probability and FDR of protein IDs

ROC curves illustrate the discriminative capability of the scores of IDs. In the case of protein identifications, Fido produces the posterior probability of each protein as the output score. However, a perfect score should not only be highly discriminative (distinguishing true from false IDs), it should also be "calibrated" (for probability indicating that all IDs with reported posterior probability scores of 95% should roughly of 5% probability be false. This implies that the estimated number of false positives can be computed as the sum of posterior error probability ($= 1 - \text{posterior probability}$), further an posterior probability estimated FDR is also possible to be computed. Therefore, we can plot calibration curves to help us visualize the quality of the score (when the score is interpreted as a probability as Fido does), by comparing how similar the target-decoy estimated FDR and the posterior probability estimated FDR are. Good results should show a close correspondence between these two measurements.

The calculation is done by using a simple R script in R snippet. First, the target decoy protein FDR is computed as the proportion of decoy proteins among all significant protein IDs. Then posterior probabilistic-driven FDR is estimated by the average of the posterior error probability of all significant protein IDs. Since FDR is the property for a group of protein IDs, we can also calculate a local property: the q -value of a certain protein ID by the minimum value of FDRs of any groups of protein IDs that contain this protein ID. We plot the protein ID results versus two different kinds of FDR estimates in R View(Table) (see Figure 12).

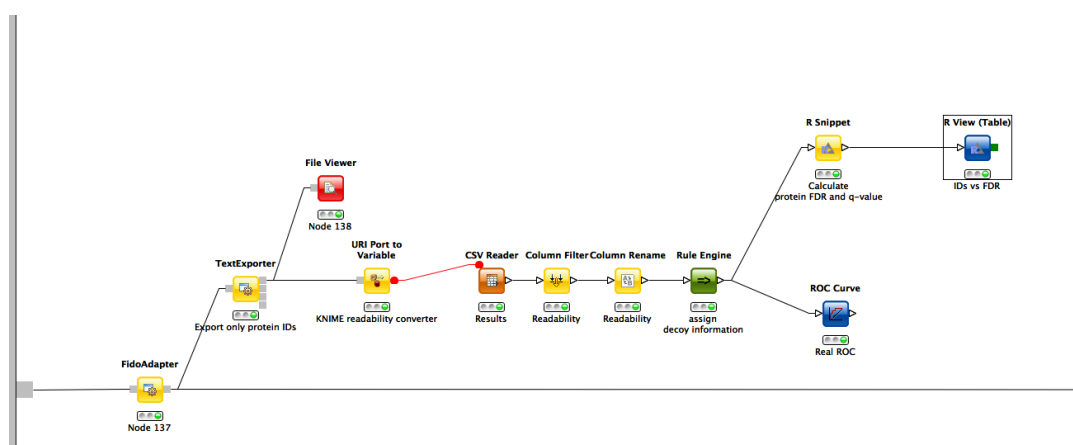

Figure 11: The workflow of statistical analysis of protein inference results

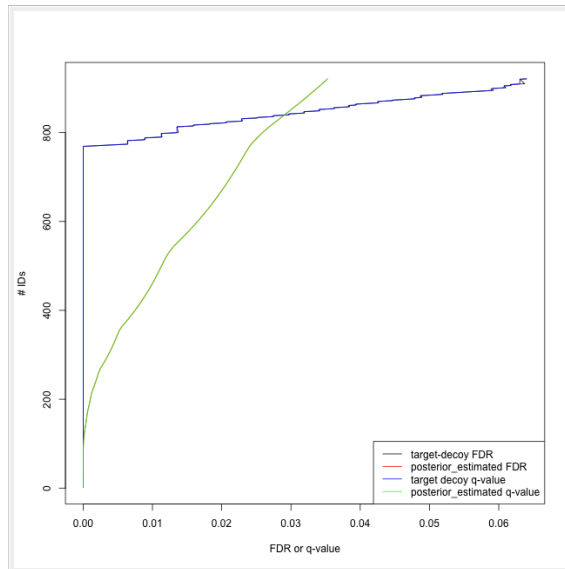

Figure 12: the pseudo-ROC Curve of protein IDs. The accumulated number of protein IDs is plotted on two kinds of scales: target-decoy protein FDR and Fido posterior probability estimated FDR. The largest value of posterior probability estimated FDR is already smaller than 0.04, this is because the posterior probability output from Fido is generally very high.

5 Metabolomics

5.1 Introduction

Quantitation and identification of chemical compounds are basic tasks in metabolomic studies. In this tutorial session we construct a UPLC-MS based, label-free quantitation and identification workflow. Following quantitation and identification we then perform statistical downstream analysis to detect quantitation values that differ significantly between two conditions. This approach can, for example, be used to detect biomarkers. Here, we use two spike-in conditions of a dilution series (0.5 mg/l and 10.0 mg/l, male blood background, measured in triplicates) comprising seven isotopically labeled compounds. The goal of this tutorial is to detect and quantify these differential spike-in compounds against the complex background.

5.2 Quantifying metabolites across several experiments

For the metabolite quantification we choose an approach similar to the one used for peptides, but this time based on the OpenMS FeatureFinderMetabo method. This feature finder again collects peak picked data into individual mass traces. The reason why we need a different feature finder for metabolites lies in the step after trace detection: the aggregation of isotopic traces belonging to the same compound ion into the same feature. Compared to peptides with their averagine model, small molecules have very different isotopic distributions. To group small molecule mass traces correctly, an aggregation model tailored to small molecules is thus needed.

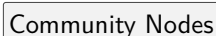
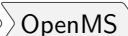
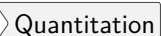
- Create a new workflow called for instance "Metabolomics".
- Add a Input Files node and configure it with all mzML files from  Example_Data ▶ Metabolomics ▶ datasets.
- Add a ZipLoopStart node and connect the Input Files node to the first port of the ZipLoopStart node.
- Add a FeatureFinderMetabo node (from  Community Nodes >>  OpenMS >>  Quantitation) and connect the first output port of the ZipLoopStart to the FeatureFinderMetabo.

- For an optimal result adjust the following settings. Please note that some of these are advanced parameters.

parameter	value
<i>algorithm</i> → <i>common</i> → <i>chrom_fwhm</i>	8.0
<i>algorithm</i> → <i>mtd</i> → <i>trace_termination_criterion</i>	sample_rate
<i>algorithm</i> → <i>mtd</i> → <i>min_trace_length</i>	3.0
<i>algorithm</i> → <i>mtd</i> → <i>max_trace_length</i>	600.0
<i>algorithm</i> → <i>epd</i> → <i>width_filtering</i>	off

- Add a ZipLoopEnd node and connect the output of the FeatureFinderMetabo to the first port of the ZipLoopEnd node.

To facilitate the collection of features corresponding to the same compound ion across different samples, an alignment of the samples' feature maps along retention time is often helpful. In addition to local, small-scale elution differences, one can often see constant retention time shifts across large sections between samples. We can use linear transformations to correct for these large scale retention differences. This brings the majority of corresponding compound ions close to each other. Finding the correct corresponding ions is then faster and easier, as we don't have to search as far around individual features.

- After the ZipLoopEnd node add a MapAlignerPoseClustering node (Community Nodes > OpenMS > Map Alignment), set its Output Type to featureXML, and adjust the following settings

parameter	value
<i>algorithm</i> → <i>max_num_peaks_considered</i>	-1
<i>algorithm</i> → <i>superimposer</i> → <i>mz_pair_max_distance</i>	0.005
<i>algorithm</i> → <i>superimposer</i> → <i>num_used_points</i>	10000
<i>algorithm</i> → <i>pairfinder</i> → <i>distance_RT</i> → <i>max_difference</i>	20.0
<i>algorithm</i> → <i>pairfinder</i> → <i>distance_MZ</i> → <i>max_difference</i>	20.0
<i>algorithm</i> → <i>pairfinder</i> → <i>distance_MZ</i> → <i>unit</i>	ppm

The next step after retention time correction is the grouping of corresponding features in multiple samples. In contrast to the previous alignment, we assume no linear relations of features across samples. The used method is tolerant against local swaps in elution order.

- After the `MapAlignerPoseClustering` add a `FeatureLinkerUnlabeledQT` (Community Nodes >> OpenMS >> Map Alignment) and adjust the following settings

parameter	value
<code>algorithm → distance_RT → max_difference</code>	40.0
<code>algorithm → distance_MZ → max_difference</code>	20.0
<code>algorithm → distance_MZ → unit</code>	ppm

- After the `FeatureLinkerUnlabeledQT` add a `TextExporter` node (Community Nodes >> OpenMS >> File Handling).
- Add an `Output Folder` node and configure it with an output directory where you want to store the resulting files.
- Run the pipeline and inspect the output.

You should find a single, tab-separated file containing the information on where metabolites were found and with which intensities. You can also add `Output Folder` nodes at different stages of the workflow and inspect the intermediate results (e.g., identified metabolite features for each input map). The complete workflow can be seen in Figure 13. In the following section we will try to identify those metabolites.

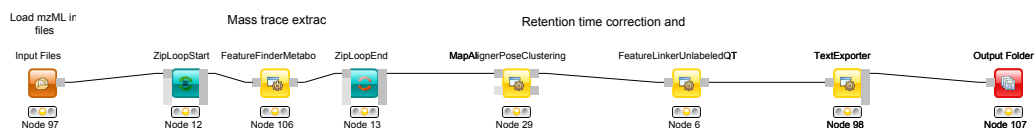

Figure 13: Label-free quantification workflow for metabolites

5.3 Identifying metabolites in LC-MS/MS samples

At the current state we found several metabolites in the individual maps but so far don't know what they are. To identify metabolites OpenMS provides multiple tools, including search by mass: the `AccurateMassSearch` node searches observed masses against the Human Metabolome Database (HMDB)[8, 9, 10]. We start with the workflow from the previous section (see Figure 13).

- Add a `FileConverter` node and connect the output of the `FeatureLinkerUnlabeledQT` to the incoming port.
- Open the Configure dialog of the `FileConverter` and select the tab "OutputTypes". In the drop down list for `FileConverter.1.out` select "featureXML".
- Add an `AccurateMassSearch` node and connect the output of the `FileConverter` to the first port of the `AccurateMassSearch`.
- Add four `Input File` nodes and configure them with the following files
 - `Example_Data` ▶ `Metabolomics` ▶ `databases` ▶ `PositiveAdducts.tsv`
This file specifies the list of adducts that are considered in the positive mode. Each line contains the formula and charge of an adduct separated by a semi-colon (e.g. `M+H;1+`). The mass of the adduct is calculated automatically.
 - `Example_Data` ▶ `Metabolomics` ▶ `databases` ▶ `NegativeAdducts.tsv`
This file specifies the list of adducts that are considered in the negative mode analogous to the positive mode.
 - `Example_Data` ▶ `Metabolomics` ▶ `databases` ▶ `HMDBMappingFile.tsv`
This file contains information from a metabolite database in this case from HMDB. It has three (or more) tab-separated columns: mass, formula, and identifier(s). This allows for an efficient search by mass.
 - `Example_Data` ▶ `Metabolomics` ▶ `databases` ▶ `HMDB2StructMapping.tsv`
This file contains additional information about the identifiers in the mapping file. It has four tab-separated columns that contain the identifier, name, SMILES, and INCHI. These will be included in the result file. The identifiers in this file must match the identifiers in the `HMDBMappingFile.tsv`.

- In the same order as they are given above connect them to the remaining input ports of the AccurateMassSearch node.
- Add an Output Folder node and connect the first output port of the AccurateMassSearch node to the Output Folder.

The result of the AccurateMassSearch node is in the mzTab format [11] so you can easily open it in a text editor or import it into Excel or KNIME, which we will do in the next section. The complete workflow from this section is shown in Figure 14.

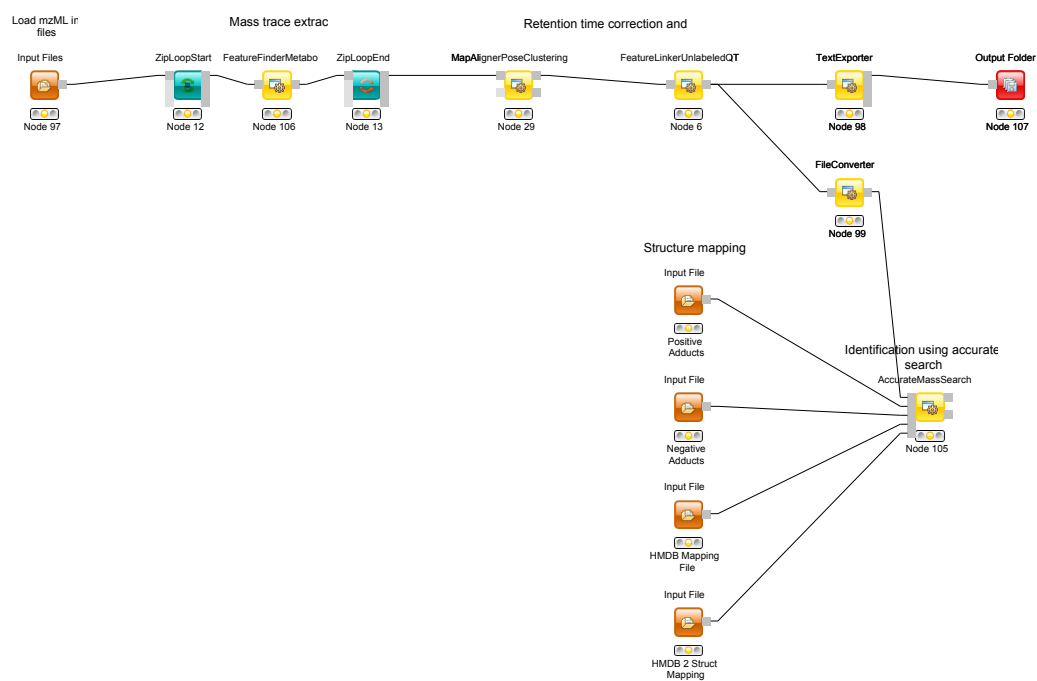

Figure 14: Label-free quantification and identification workflow for metabolites

5.4 Convert your data into a KNIME table

The result from the TextExporter node as well as the result from the AccurateMassSearch node are files while standard KNIME nodes display and processes only KNIME tables. To convert these files into KNIME tables we need two different nodes. For the AccurateMassSearch results we use the MzTabReader node (Community Nodes >> OpenMS >> Conversion)

mzTab), for the result of the TextExporter we use the ConsensusTextReader (Community Nodes OpenMS Conversion).

When executed, both nodes will import the OpenMS files and provide access to the data as KNIME tables. You can now easily combine both tables using the Joiner node (Data Manipulation Column Split & Combine) and configuring it to match the m/z and retention time values of the respective tables. The full workflow is shown in Figure 15.

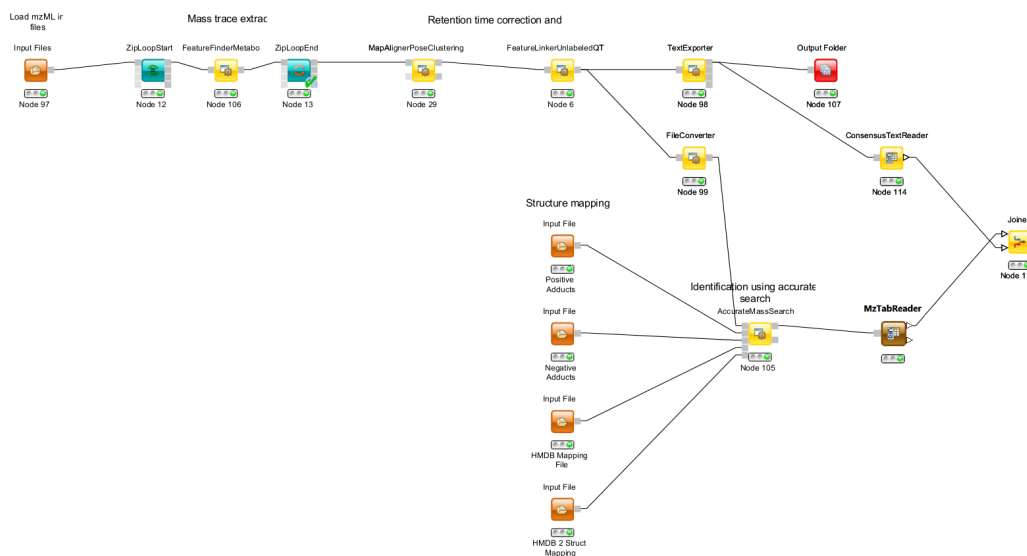

Figure 15: Label-free quantification and identification workflow for metabolites that loads the results into KNIME and joins the tables.

5.4.1 Bonus task: Visualizing data

Now that you have your data in KNIME you should try to get a feeling for the capabilities of KNIME.

Task



Check out the Molecule Type Cast node (Chemistry Translators) together with subsequent cheminformatics nodes (e.g. RDKit From Molecule (Community Nodes RDKit Converters)) to render the structural formula contained in the result table.

Task



Have a look at the Column Filter node to reduce the table to the interesting columns, e.g., only the Ids, chemical formula, and intensities.

Task





Try to compute and visualize the m/z and retention time error of the different elements of the consensus features.

5.5 Downstream data analysis and reporting

In this part of the metabolomics session we take a look at more advanced downstream analysis and the use of the statistical programming language R. As laid out in the introduction we try to detect a set of spike-in compounds against a complex blood background. As there are many ways to perform this type of analysis we provide a complete workflow.

Task



Import the workflow from  Workflows ▶ metabolite_ID.zip in KNIME:  

The section below will guide you in your understanding of the different parts of the workflow. Once you understood the workflow you should play around and be creative. Maybe create a novel visualization in KNIME or R? Do some more elaborate statistical analysis? Feel free to experiment and show us your results if you like. Note that some basic R knowledge is required to fully understand the processing in R Snippet nodes.

5.5.1 Data preparation ID

This part is analogous to what you did for the simple metabolomics pipeline.

5.5.2 Data preparation Quant

The first part is identical to what you did for the simple metabolomics pipeline. Additionally, we convert zero intensities into NA values and remove all rows that contain at least

one NA value from the analysis. We do this using a very simple R Snippet and subsequent Missing Value filter node.

Task



Inspect the R Snippet by double-clicking on it. The KNIME table that is passed to an R Snippet node is available in R as a data.frame named `knime.in`. The result of this node will be read from the data.frame `knime.out` after the script finishes. Try to understand and evaluate parts of the script (Eval Selection). In this dialog you can also print intermediary results using for example the R command `head()` or `cat()` to the Console pane.

5.5.3 Statistical analysis



After we linked features across all maps, we want to identify features that are significantly deregulated between the two conditions. We will first scale and normalize the data, then perform a t-test, and finally correct the obtained p-values for multiple testing using Benjamini-Hochberg. All of these steps will be carried out in individual R Snippet nodes.

- Double-click on the first R Snippet node labeled "log scaling" to open the R Snippet dialog. In the middle you will see a short R script that performs the log scaling. To perform the log scaling we use a so-called regular expression (`grep`) to select all columns containing the intensities in the six maps and take the \log_2 logarithm.
- The output of the log scaling node is also used to draw a boxplot that can be used to examine the structure of the data. Since we only want to plot the intensities in the different maps (and not `m/z` or `rt`) we first use a Column Filter node to keep only the columns that contain the intensities. We connect the resulting table to a Box Plot node which draws one box for every column in the input table. Right-click and select `View: Box Plot`.
- The median normalization is performed in a similar way to the log scaling. First we calculate the median intensity for each intensity column, then we subtract the median from every intensity.

- Open the Box Plot connected to the normalization node and compare it to the box plot connected to the log scaling node to examine the effect of the median normalization.
- To perform the t-test we defined the two groups we want to compare. Then we call the t-test for every consensus feature unless it has missing values. Finally we save the p-values and fold-changes in two new columns named p-value and FC.
- The Numeric Row Splitter is used to filter less interesting parts of the data. In this case we only keep columns where the fold-change is ≥ 2 .
- We adjust the p-values for multiple testing using Benjamini-Hochberg and keep all consensus features with a q-value ≤ 0.01 (i.e. we target a false-discovery rate of 1%).

5.5.4 Interactive visualization

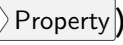
KNIME supports multiple nodes for interactive visualization with interrelated output. The nodes used in this part of the workflow exemplify this concept. They further demonstrate how figures with data dependent customization can be easily realized using basic KNIME nodes. Several simple operations are concatenated in order to enable an interactive volcano plot.

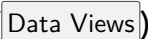
- We first log-transform fold changes and p-values in the R Snippet node. We then append columns noting interesting features (concerning fold change and p-value).
- With this information, we can use various Manager nodes ( ) to emphasize interesting data points. The configuration dialogs allow us to select columns to change color, shape or size of data points dependent on the column values.
- The Scatter Plot node () enables interactive visualization of the logarithmized values as a volcano plot: the log-transformed values can be chosen in the 'Column Selection' tab of the plot view. Data points can be selected in the plot and HiLited via the menu option. HiLiteing transfers to all other interactive nodes connected to the same data table. In our case, selection and HiLiteing will also occur in the Interactive Table node ()

- Output of the interactive table can then be filtered via the HiLite menu tab. For example, we could restrict shown rows to points HiLited in the volcano plot.

Task



Inspect the nodes of this section. Customize your visualization and possibly try to visualize other aspects of your data.

5.5.5 Advanced visualization

R Dependencies: This section requires that the R packages `ggplot2` and `ggbiplot` are both installed. `ggplot2` is part of the *KNIME R Statistics Integration (Windows Binaries)* which should already be installed via the full KNIME installer, `ggbiplot` however is not. In case that you use an R installation where one or both of them are not yet installed, add an R Snippet node and double-click to configure. In the *R Script* text editor, enter the following code:

```
#Include the next line if you also have to install ggplot2:  
install.packages("ggplot2")  
#Include the following lines to install ggbiplot:  
install.packages("devtools")  
library(devtools)  
install_github("vqv/ggbiplot")
```

Press to execute the script.

Even though the basic capabilities for (interactive) plots in KNIME are valuable for initial data exploration, professional looking depiction of analysis results often relies on dedicated plotting libraries. The statistics language R supports the addition of a large variety of packages, including packages providing extensive plotting capabilities. This part of the workflow shows how to use R nodes in KNIME to visualize more advanced figures. Specifically, we make use of different plotting packages to realize heatmaps.

- The used *RView (Table)* nodes combine the possibility to write R snippet code with visualization capabilities inside KNIME. Resulting images can be looked at in the output *RView*, or saved via the *Image Port Writer* node.

- The heatmap nodes make use of the `gplots` library, which is by default part of the R Windows binaries for the KNIME 3.1.1 full installation. We again use regular expressions to extract all measured intensity columns for plotting. For clarity, feature names are only shown in the heatmap after filtering by fold changes.

5.5.6 Data preparation for Reporting

Following the identification, quantification and statistical analysis our data is merged and formatted for reporting. First we want to discard our normalized and logarithmized intensity values in favor of the original ones. To this end we first remove the intensity columns (Column Filter) and add the original intensities back (Joiner). Note that we use an *Inner Join*¹. Combining ID and Quantification table into a single table is again achieved using a Joiner node.

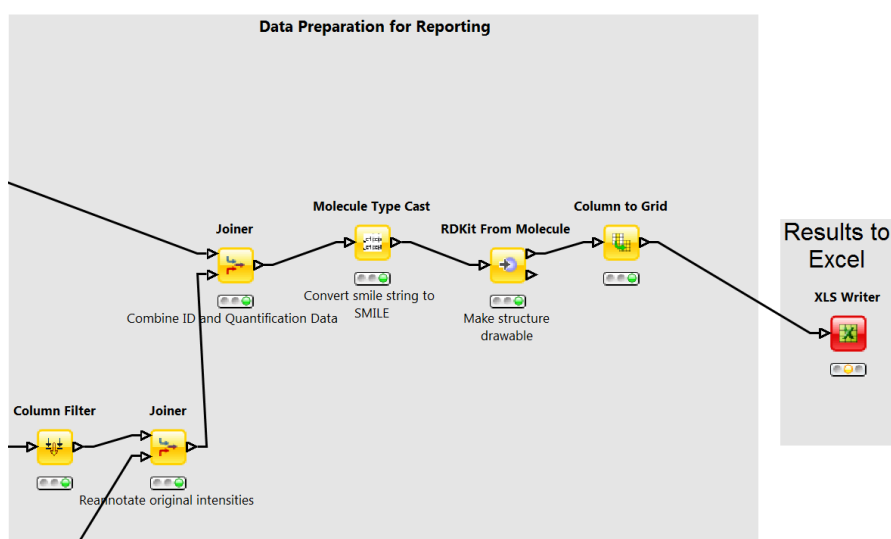

Figure 16: Data preparation for reporting

Question



What happens if we use an *Left Outer Join*, *Right Outer Join* or *Full Outer Join* instead of the *Inner Join*?

¹*Inner Join* is a technical term that describes how database tables are merged.

Task



Inspect the output of the join operation after the Molecule Type Cast and RDKit molecular structure generation.

While all relevant information is now contained in our table the presentation could be improved. Currently, we have several rows corresponding to a single consensus feature (=linked feature) but with different, alternative identifications. It would be more convenient to have only one row for each consensus feature with all accurate mass identifications added as additional columns. To this end, we use the `Column to Grid` node that flattens several rows with the same consensus number into a single one. Note that we have to specify the maximum number of columns in the grid so we set this to a large value (e.g. 100). We finally export the data to an Excel file (`XLS Writer`).

6 OpenSWATH

6.1 Introduction

OpenSWATH [12] is a module of OpenMS that allows analysis of LC-MS/MS DIA (data independent acquisition) data using the approach described by Gillet *et al.* [13]. The DIA approach described there uses 32 cycles to iterate through precursor ion windows from 400-426 Da to 1175-1201 Da and at each step acquires a complete, multiplexed fragment ion spectrum of all precursors present in that window. After 32 fragmentations (or 3.2 seconds), the cycle is restarted and the first window (400-426 Da) is fragmented again, thus delivering complete "snapshots" of all fragments of a specific window every 3.2 seconds.

The analysis approach described by Gillet *et al.* extracts ion traces of specific fragment ions from all MS2 spectra that have the same precursor isolation window, thus generating data that is very similar to SRM traces.

6.2 Installation of OpenSWATH

OpenSWATH has been fully integrated since OpenMS 1.10 [3, 2, 14]).

6.3 Installation of mProphet

mProphet (<http://www.mprophet.org/>) [15] is available as standalone script in `External_Tools` ▶ `mProphet`. R (<http://www.r-project.org/>) and the package MASS (<http://cran.r-project.org/web/packages/MASS/>) are further required to execute mProphet. Please obtain a version for either Windows, Mac or Linux directly from CRAN.

pyprophet, a much faster reimplementation of the mProphet algorithm is available from PyPI (<https://pypi.python.org/pypi/pyprophet/>). The usage of pyprophet instead of mProphet is suggested for large-scale applications, but the installation requires more dependencies and therefore, for this tutorial the application of mProphet is described.

6.4 Generating the Assay Library

6.4.1 Generating TraML from transition lists

OpenSWATH requires the assay libraries to be supplied in the TraML format [16]. To enable manual editing of transition lists, the TOPP tool `ConvertTSVToTraML` is available that uses tab separated files as input. Example datasets are provided in `OpenSWATH\assay`. Please note that the transition lists need to be named `.csv` or `.tsv`.

The header of the transition list contains the following variables (with example values in brackets):

PrecursorMz

The mass-to-charge (m/z) of the precursor ion. (728.88)

ProductMz

The mass-to-charge (m/z) of the product or fragment ion. (924.539)

Tr_recalibrated

The **normalized** retention time (or iRT) [17] of the peptide. (26.5)

transition_name

A **unique** identifier for the transition.

(AQUA4SWATH_HMLangeA_ADSTGLVITDPTR(UniMod:267)/2_y8)

CE

The collision energy that should be used for the acquisition. (27)

Optional (not used by OpenSWATH)

LibraryIntensity

The relative intensity of the transition. (3305.3)

transition_group_id

A **unique** identifier for the transition group.

(AQUA4SWATH_HMLangeA_ADSTGLVITDPTR(UniMod:267)/2)

decoy

A binary value whether the transition is target or decoy (target:0, decoy:1). (0)

PeptideSequence

The unmodified peptide sequence. (ADSTGTLVITDPTR)

ProteinName

A unique identifier for the protein. (AQUA4SWATH_HMLangeA)

Annotation

The fragment ion annotation. (y8)
Optional (not used by OpenSWATH)

FullUniModPeptideName

The peptide sequence with UniMod modifications. (ADSTGTLVITDPTR(UniMod:267))

MissedCleavages

The number of missed cleavages during enzymatic digestion. (0)
Optional (not used by OpenSWATH)

Replicates

The number of replicates. (0)
Optional (not used by OpenSWATH)

NrModifications

The number of modifications. (0)
Optional (not used by OpenSWATH)

PrecursorCharge

The precursor ion charge. (2)

GroupLabel

The stable isotope label. (light)
Optional (not used by OpenSWATH)

UniprotID

The Uniprot ID of the protein. ()
Optional (not used by OpenSWATH)

To convert transitions lists to TraML, use `ConvertTSVToTraML`:

Linux or Mac

On the Terminal:

```
ConvertTSVToTraML -in OpenSWATH_SGS_AssayLibrary.csv -out OpenSWATH_SGS_AssayLibrary.↔  
TraML
```

Windows

On the TOPP command line:

```
ConvertTSVToTraML.exe -in OpenSWATH_SGS_AssayLibrary.csv -out OpenSWATH_SGS_AssayLibrary↔  
.TraML
```

6.4.2 Appending decoys to a TraML

In addition to the target assays, OpenSWATH further requires decoy assays in the library which are later used for classification and error rate estimation. For the decoy generation it is crucial that the decoys represent the targets in a realistic but unnatural manner without interfering with the targets. The methods for decoy generation implemented in OpenSWATH include 'shuffle', 'pseudo-reverse', 'reverse' and 'shift'. To append decoys to a TraML, the TOPP tool `OpenSwathDecoyGenerator` can be used:

Linux or Mac

On the Terminal:

```
OpenSwathDecoyGenerator -in OpenSWATH_SGS_AssayLibrary.TraML -out ↔  
OpenSWATH_SGS_AssayLibrary_with_Decoy.TraML -method shuffle -append ↔  
exclude_similar -remove_unannotated
```

Windows

On the TOPP command line:

```
OpenSwathDecoyGenerator.exe -in OpenSWATH_SGS_AssayLibrary.TraML -out ↔  
OpenSWATH_SGS_AssayLibrary_with_Decoy.TraML -method shuffle -append ↔  
exclude_similar -remove_unannotated
```

The flag `-append` generates an output TraML with the complete set of decoy and target assays. The flag `-exclude_similar` is used to exclude decoys which are very similar to the target assays.

6.5 OpenSWATH KNIME

An example KNIME workflow for OpenSWATH is supplied in `Workflows` (Figure ??). The example dataset can be used for this workflow (filenames in brackets):

1. Open `Workflows` ▶ `OpenSWATH.zip` in KNIME: `File` ▶ `Import KNIME Workflow...`.
2. Select the normalized retention time (iRT) assay library in TraML format by double-clicking on node `Input File` ▶ `iRT Assay Library`.
(`OpenSWATH` ▶ `assay` ▶ `OpenSWATH_iRT_AssayLibrary.TraML`)
3. Select the SWATH MS data in mzML format as input by double-clicking on node `Input File` ▶ `SWATH-MS files`.
(`OpenSWATH` ▶ `data` ▶ `split_napedro_L120420_010_SW-*.nf.pp.mzML`)
4. Select the target peptide assay library in TraML format as input by double-clicking on node `Input Files` ▶ `Assay Library`.
(`OpenSWATH` ▶ `assay` ▶ `OpenSWATH_SGS_AssayLibrary.TraML`)
5. Set the output destination by double-clicking on node `Output File`.
6. Run the workflow.

The resulting output can be found at your selected path, which will be used as input for mProphet. Execute the script on the Terminal (Linux or Mac) or `cmd.exe` (Windows) in `OpenSWATH` ▶ `result`:

```
R --slave --args bin_dir=../../External_Tools/mProphet/ mquest=OpenSWATH_output.csv workflow=↔
LABEL_FREE num_xval=5 run_log=FALSE write_classifier=1 write_all_pg=1 < ../../↔
External_Tools/mProphet/mProphet.R
```

The main output will be called

OpenSWATH › result › mProphet_all_peakgroups.xls

with statistical information available in

OpenSWATH › result › mProphet.pdf.

Please note that due to the semi-supervised machine learning approach of mProphet the results differ slightly when mProphet is executed several times.

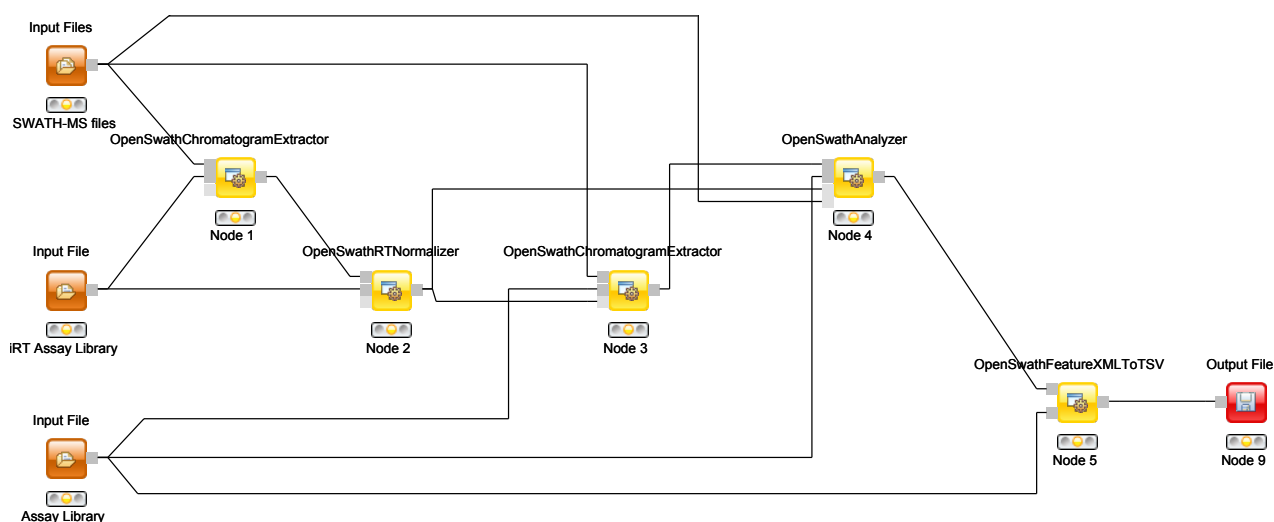

Figure 17: OpenSWATH KNIME Workflow.

6.6 From the example dataset to real-life applications

The sample dataset used in this tutorial is part of the larger SWATH MS Gold Standard (SGS) dataset which is described in the publication of Roest et al. [12]. It contains one of 90 SWATH-MS runs with significant data reduction (peak picking of the raw, profile data) to make file transfer and working with it easier. Usually SWATH-MS datasets are huge with several gigabyte per run. Especially when complex samples in combination with large assay libraries are analyzed, the TOPP tool based workflow requires a lot of computational resources. For this reason, an integrated tool (OpenSwathWorkflow) has been developed, combining all the steps shown in the KNIME-Workflow into a single executable. It is shipped with OpenMS 2.0.0. Instructions on how to use this tool can be found on <http://www.openswath.org>.

7 An introduction to pyOpenMS

7.1 Introduction

pyOpenMS provides Python bindings for a large part of the OpenMS library for mass spectrometry based proteomics. It thus provides access to a feature-rich, open-source algorithm library for mass-spectrometry based proteomics analysis. These Python bindings allow raw access to the data-structures and algorithms implemented in OpenMS, specifically those for file access (mzXML, mzML, TraML, mzIdentML among others), basic signal processing (smoothing, filtering, de-isotoping and peak-picking) and complex data analysis (including label-free, SILAC, iTRAQ and SWATH analysis tools).

pyOpenMS is integrated into OpenMS starting from version 1.11. This tutorial is addressed to people already familiar with Python. If you are new to Python, we suggest to start with a Python tutorial (http://en.wikibooks.org/wiki/Non-Programmer%27s_Tutorial_for_Python_2.6).

7.2 Installation

7.2.1 Windows

1. Install Python 2.7 (<http://www.python.org/download/>)
2. Install NumPy (<http://www.lfd.uci.edu/~gohlke/pythonlibs/#numpy>)
3. Install setuptools (<https://pypi.python.org/pypi/setuptools>)
4. On the command line:

```
easy_install pyopenms
```

7.2.2 Mac OS X 10.10

1. On the Terminal:

```
sudo easy_install pyopenms
```

7.2.3 Linux

1. Install Python 2.6 or 2.7 (Debian: python-dev, RedHat: python-devel)
2. Install NumPy (Debian / RedHat: python-numpy)
3. Install setuptools (Debian / RedHat: python-setuptools)
4. On the Terminal:

```
easy_install pyopenms
```

7.3 Build instructions

Instructions on how to build pyOpenMS can be found online (<http://ftp.mi.fu-berlin.de/OpenMS/documentation/html/pyOpenMS.html>).

7.4 Your first pyOpenMS tool: pyOpenSwathFeatureXMLToTSV

The first tool that you are going to re-implement is a TOPP tool called OpenSwathFeatureXMLToTSV. Take a look at the help of the tool:

```
OpenSwathFeatureXMLToTSV —help

OpenSwathFeatureXMLToTSV — Converts a featureXML to a mProphet tsv.
Version: 2.0.0 Apr 11 2015, 02:02:58, Revision: 66a7739

Usage:
  OpenSwathFeatureXMLToTSV <options>

Options (mandatory options marked with '*'):
  -in <files>*           Input files separated by blank (valid formats: 'featureXML')
  -tr <file>*            TraML transition file (valid formats: 'traML')
  -out <file>*           Tsv output file (mProphet compatible) (valid formats: 'csv')
  -short_format           Whether to write short (one peptide per line) or long format (←
                        one transition per line).
```

```
-best_scoring_peptide <varname> If only the best scoring feature per peptide should be printed↔  
    , give the variable name
```

Common TOPP options:

```
-ini <file> Use the given TOPP INI file  
-threads <n> Sets the number of threads allowed to be used by the TOPP tool↔  
    (default: '1')  
-write_ini <file> Writes the default configuration file  
-help Shows options  
-helphelp Shows all options (including advanced)
```

OpenSwathFeatureXMLToTSV converts a featureXML file to a tab-separated value text file. This example will teach you how to use pyOpenMS in combination with Python to implement such a tool very quickly.

7.4.1 Basics

The first task that your tool needs to be able to do is to read the parameters from the command line and provide a main routine. This is all standard Python and no pyOpenMS is needed so far:

```
#!/usr/bin/env python  
import sys  
  
def main(options):  
  
    # test parameter handling  
    print options.infile, options.traml_in, options.outfile  
  
def handle_args():  
    import argparse  
  
    usage = ""  
    usage += "\nOpenSwathFeatureXMLToTSV -- Converts a featureXML to a mProphet tsv."  
  
    parser = argparse.ArgumentParser(description = usage )  
    parser.add_argument('-in', dest='infile', help = 'An input file containing []features ↔  
        featureXMLJ')  
    parser.add_argument('-tr', dest='traml_in', help='An input file containing the transitions ↔  
        TraMLJ')  
    parser.add_argument('-out', dest='outfile', help='Output mProphet TSV file [tsv]')  
  
    args = parser.parse_args(sys.argv[1:])  
    return args
```

```
if __name__ == '__main__':
    options = handle_args()
    main(options)
```

Execute this code in the example script

```
./pyOpenMS/OpenSwathFeatureXMLToTSV_basics.py
```

```
python OpenSwathFeatureXMLToTSV_basics.py --help
usage: OpenSwathFeatureXMLToTSV_basics.py [-h] [--in INFILE] [--tr TRAML_IN]
      [-out OUTFILE]
```

OpenSwathFeatureXMLToTSV -- Converts a featureXML to a mProphet tsv.

optional arguments:

```
-h, --help      show this help message and exit
--in INFILE     An input file containing features [featureXML]
--tr TRAML_IN  An input file containing the transitions [TraML]
--out OUTFILE  Output mProphet TSV file [tsv]
```

```
python OpenSwathFeatureXMLToTSV_basics.py --in data/example.featureXML --tr assay/↔
OpenSWATH_SGS_AssayLibrary.TraML --out example.tsv
data/example.featureXML assay/OpenSWATH_SGS_AssayLibrary.TraML example.tsv
```

The parameters are being read from the command line by the function `handle_args()` and given to the `main()` function of the script, which prints the different variables.

7.4.2 Loading data structures with pyOpenMS

Now we're going to import the `pyOpenMS` module with `import pyopenms` in the header of the script and load the `featureXML`:

```
#!/usr/bin/env python
import pyopenms
import sys

def main(options):
    # load featureXML
    features = pyopenms.FeatureMap()
    fh = pyopenms.FileHandler()
```

```

fh.loadFeatures(options.infile, features)
keys = []
features[0].getKeys(keys)
print keys

def handle_args():
    import argparse

    usage = ""
    usage += "\nOpenSwathFeatureXMLToTSV -- Converts a featureXML to a mProphet tsv."

    parser = argparse.ArgumentParser(description = usage )
    parser.add_argument('-in', dest='infile', help = 'An input file containing features [↔
        featureXML]')
    parser.add_argument('-tr', dest='traml_in', help='An input file containing the transitions [↔
        TraML]')
    parser.add_argument('-out', dest='outfile', help='Output mProphet TSV file [tsv]')

    args = parser.parse_args(sys.argv[1:])
    return args

if __name__ == '__main__':
    options = handle_args()
    main(options)

```

The function `pyopenms.FeatureMap()` initializes an OpenMS FeatureMap data structure. The function `pyopenms.FileHandler()` prepares a filehandler with the variable name `fh` and `fh.loadFeatures(options.infile, features)` takes the filename and imports the featureXML into the FeatureMap data structure.

In the next step, we're accessing the keys using the function `getKeys()` and printing them to stdout:

```

python OpenSwathFeatureXMLToTSV_datastructures1.py -in data/example.featureXML -tr assay/↔
OpenSWATH_SGS_AssayLibrary.TraML -out example.tsv
['PeptideRef', 'leftWidth', 'rightWidth', 'total_xic', 'peak_apices_sum', 'var_xcorr_coelution', ↔
'var_xcorr_coelution_weighted ', 'var_xcorr_shape', 'var_xcorr_shape_weighted', '↔
var_library_corr', 'var_library_rmsd', 'var_library_manhattan', 'var_library_dotprod', '↔
delta_rt', 'assay_rt', 'norm_RT', 'rt_score', 'var_norm_rt_score', 'var_intensity_score', '↔
nr_peaks', 'sn_ratio', 'var_log_sn_score', 'var_elution_model_fit_score', '↔
xx_lda_prelim_score', 'var_isotope_correlation_score', 'var_isotope_overlap_score', '↔
var_massdev_score', 'var_massdev_score_weighted', 'var_bseries_score', 'var_yseries_score', ↔
'var_dotprod_score', 'var_manhatt_score', 'main_var_xx_swath_prelim_score', 'PrecursorMZ', '↔
xx_swath_prelim_score']

```

In the next task, please load the TraML into an OpenMS TargetedExperiment data structure, analogously to the featureXML. You might want to consult the pyOpenMS manual (http://proteomics.ethz.ch/pyOpenMS_Manual.pdf), which provides an overview of all functionality. If you have trouble reading the TraML, search for TraMLFile(). If you can't solve the task, take a look at OpenSwathFeatureXMLToTSV_datastructures2.py

7.4.3 Converting data in the featureXML to a TSV

Now that all data structures are populated, we need to access the data using the provided API and store it in something that is directly accessible from Python. We prepared two functions for you: get_header() & convert_to_row():

```
def get_header(features):
    keys = []
    features[0].getKeys(keys)
    header = [
        "transition_group_id",
        "run_id",
        "filename",
        "RT",
        "id",
        "Sequence",
        "FullPeptideName",
        "Charge",
        "m/z",
        "Intensity",
        "ProteinName",
        "decoy"]
    header.extend(keys)
    return header
```

get_header() takes as input a FeatureMap and uses the getKeys() function that you have seen before to extend a predefined header list based on the contents of the FeatureMap. The return variable is a native Python list.

```
def convert_to_row(first, targ, run_id, keys, filename):
    peptide_ref = first.getMetaValue("PeptideRef")
    pep = targ.getPeptideByRef(peptide_ref)
    full_peptide_name = "NA"
    if (pep.metaValueExists("full_peptide_name")):
        full_peptide_name = pep.getMetaValue("full_peptide_name")
```

```

decoy = "0"
peptidetransitions = [t for t in targ.getTransitions() if t.getPeptideRef() == peptide_ref]
if len(peptidetransitions) > 0:
    if peptidetransitions[0].getDecoyTransitionType() == pyopenms.DecoyTransitionType().DECOY↔
        :
        decoy = "1"
    elif peptidetransitions[0].getDecoyTransitionType() == pyopenms.DecoyTransitionType().↔
        TARGET:
        decoy = "0"

protein_name = "NA"
if len(pep.protein_refs) > 0:
    protein_name = pep.protein_refs[0]

row = [
    first.getMetaValue("PeptideRef"),
    run_id,
    filename,
    first.getRT(),
    first.getUniqueId(),
    pep.sequence,
    full_peptide_name,
    pep.getChargeState(),
    first.getMetaValue("PrecursorMZ"),
    first.getIntensity(),
    protein_name,
    decoy
]

for k in keys:
    row.append(first.getMetaValue(k))

return row

```

convert_to_row() is a bit more complicated and takes as first input a Feature OpenMS class. From this, we access stored values using the provided functions (getRT(), getUniqueId(), etc). It further takes a TargetedExperiment to access information from the TraML with the provided routines. This data is then stored in a standard Python list with the variable name row and returned.

7.4.4 Putting things together

Now put these two functions into the header of

OpenSwathFeatureXMLToTSV_datastructures2.py.

Your final goal is to implement the conversion functionality into the main function using `get_header()` & `convert_to_row()` and to write a TSV using the standard `csv` module from Python <http://docs.python.org/2/library/csv.html>. Compare the results with `./result/example.tsv`. Are the results identical? Congratulations to your first `pyOpenMS` tool!

Hint: If you struggle at any point, take a look at `OpenSwathFeatureXMLToTSV_solution.py`.

7.4.5 Bonus task

Task



Implement all other 184 TOPP tools using `pyOpenMS`.

8 Quality control

8.1 Introduction

In this chapter, we will build on an existing workflow with OpenMS / KNIME to add some quality control (QC). We will utilize the qcML tools in OpenMS to create a file with which we can collect different measures of quality to the mass spectrometry runs themselves and the applied analysis. The file also serves the means of visually reporting on the collected quality measures and later storage along the other analysis result files. We will, step-by-step, extend the label-free quantitation workflow from section 3 with QC functions and thereby enrich each time the report given by the qcML file. But first, to make sure you get the most of this tutorial section, a little primer on how we handle QC on the technical level.

QC metrics and qcML

To assert the quality of a measurement or analysis we use quality metrics. Metrics are describing a certain aspect of the measurement or analysis and can be anything from a single value, over a range of values to a image plot or other summary. Thus, qcML metric representation is divided into QC parameters (QP) and QC attachments (QA) to be able to represent all sorts of metrics on a technical level.

A QP may (or may not) have a value which would equal a metric describable with a single value. If the metric is more complex and needs more than just a single value, the QP does not require the single value but rather depends on an attachment of values (QA) for full meaning. Such a QA holds the plot or the range of values in a table-like form. Like this, we can describe any metric by a QP and an optional QA.

To assure a consensual meaning of the quality parameters and attachments, we created a controlled vocabulary (CV). Each entry in the CV describes a metric or part/extension thereof. We embed each parameter or attachment with one of these and by doing so, connect a meaning to the QP/QA. Like this, we later know exactly what we collected and the programs can find and connect the right dots for rendering the report or calculating new metrics automatically. You can find the constantly growing controlled vocabulary here:

<https://github.com/qcML/qcML-development/blob/master/cv/qc-cv.obo>.

Finally, in a qcml file, we split the metrics on a per mass-spectrometry-run base or a set of mass-spectrometry-runs respectively. Each run or set will contain its QP/QA we calculate for it, describing their quality.



8.2 Building a qcML file per run

Note: For this part of the tutorial, you need the latest version of OpenMS in KNIME (bleeding edge development version). Therefore you have to add the software site <http://tech.knime.org/update/community-contributions/trunk/> in KNIME's **Help** **Install New Software** menu and update OpenMS.

As a start, we will build a basic qcML file for each mzML file in the label-free analysis. We are already creating the two necessary analysis files to build a basic qcML file upon each mzML file, a feature file and an identification file. We use the QCCreator node from **Community Nodes** **OpenMS** **Utilities** where also all other QC* nodes will be found. The QC-Creator will create a very basic qcML file in which it will store collected and calculated quality data.

- Copy your label-free quantitation workflow into a new lfq-qc workflow and open it.
- Place the QCCreator node after the IDMapper node. Being inside the ZipLoop, it will execute for each of the three mzML files the Input node.
- Connect the first QCCreator port to the first ZipLoopStart outlet port, which will carry the individual mzML files.
- Connect the last's ID outlet port (IDFilter or the ID metanode) to the second QC-Creator port for the identification file.
- Finally, connect the IDMapper outlet to the third QCCreator port for the feature file.

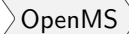
The created qcML files will not have much to show for, basic as they are. So we will extend them with some basic plots.

- First, we will add an 2D overview image of the given mass spectrometry run as you may know it from TOPPView. Add the ImageCreator node from  Community Nodes  OpenMS  Utilities. Change the *width* and *height* parameters to 640x640 as we don't want it to be too big. Connect it the first ZipLoopStart outlet port, so it will create an image file of the mzML's contained run.
- Now we have to embed this file into the qcML file, attach it to the right QualityParameter. For this, place a QCEmbedder node behind the ImageCreator and connect that to its third inlet port. Its first inlet port connect to the outlet of the QCcalculator node to pass on the qcML file. Now change the parameter *qp_att_acc* to *QC:0000055* which designates the attached image to be of type QC:0000055 - MS experiment heatmap. Finally, change the parameter *cv_acc* to *QC:0000004*, to attach the image to the QualityParameter QC:0000004 - MS acquisition result details.
- For a reference of which CVs are already defined for qcML, have a look at <https://github.com/qcML/qcML-development/blob/master/cv/qc-cv.obo>.

There are two other basic plots which we almost always might want to look at before judging the quality of a mass spectrometry run and its identifications: the *total ion current* (TIC) and the *PSM mass error* (Mass accuracy), which we have available as pre-packaged QC metanodes.

Task

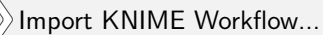
 Import the workflow from  Workflows ▶ Quality Control ▶ QC Metanodes.zip in KNIME:  File  Import KNIME Workflow...

- Copy the Mass accuracy metanode into the workflow behind the QCEmbedder node and connect it. The qcML will be passed on and the Mass accuracy plots added. The information needed was already collected by the QCcalculator.
- Do the same with the TIC metanode so that your qcML file will get passed on and enriched on each step.

R Dependencies: This section requires that the R packages ggplot2 and scales are both installed. This is the same procedure as in section 5.5.5. In case that you use an R

installation where one or both of them are not yet installed, open the R Snippet nodes inside the metanodes you just used (double-click). Edit the script in the *R Script* text editor from:

```
#install.packages("ggplot2")
#install.packages("scales")
```

to

```
install.packages("ggplot2")
install.packages("scales")
```

Press to execute the script.

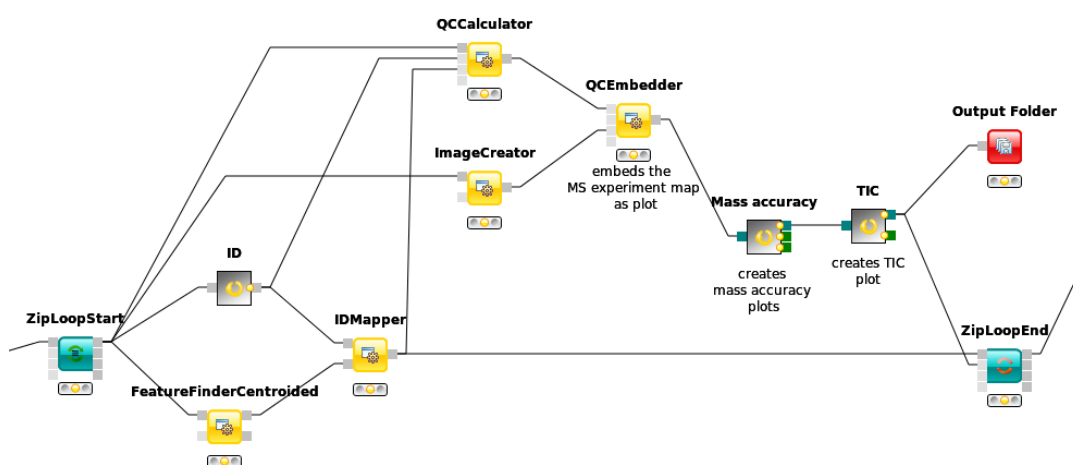

Figure 18: Basic QC setup within a LFQ workflow

Note: To have a peek into what our qcML now looks like for one of the ZipLoop iterations, we can add an `Output Folder` node from `Community Nodes` `GenericKnlmeNodes` `IO` and set its destination parameter to somewhere we want to find our intermediate qcML files in, for example `tmp` `qc_lfq`. If we now connect the last

metanode with the Output Folder and restart the workflow, we can start inspecting the qcML files.

Task





Find your first created qcML file and open it with the browser (not IE), and the contained QC parameters will be rendered for you.

8.3 Adding brand new QC metrics

We can also add brand new QC metrics to our qcML files. Remember the Histogram you added inside the ZipLoop during the label-free quantitation section? Let's imagine for a moment this was a brand new and utterly important metric and plot for the assessment of your analyses quality. There is an easy way to pick up such new finds along the workflow into your qcMLs. Though the Histogram node cannot pass its plot to an *image*, we will do with a R View (table).

- Add an R View (table) next to the IDTextReader node and connect them.
- Edit the R View (table) by adding the *R Script* according to this:

```
#install.packages("ggplot2")
library("ggplot2")
ggplot(knime.in, aes(x=peptide_charge)) +
  geom_histogram(binwidth=1, origin=-0.5) +
  scale_x_discrete() +
  ggtitle("Identified peptides charge histogram") +
  ylab("Count")
```

- This will create a plot like the Histogram node on *peptide_charge* **and** pass it on as an *image*.
- Now add and connect a Image2FilePort node from    to the R View (table).

- We can now use a QCEmbedder node like before to add our new metric plot into the qcML.
- After looking for an appropriate target in <https://github.com/qcML/qcML-development/blob/master/cv/qc-cv.obo>, we found that we can attach our plot to the *MS identification result details* by setting the parameter *qp_att_acc* to *QC:0000025*, as we are plotting the charge histogram of our *identified* peptides.
- To have the plot later displayed properly, we assign it the parameter *cv_acc* of *QC:0000051*, a *generic plot*. Also we made sure in the *R Script*, that our plot carries a caption so that we know which is which, if we had more than one new plot.
- Now we redirect the QCEmbedders output to the Output Folder from before and can have a look at how our qcML is coming along after restarting the workflow.

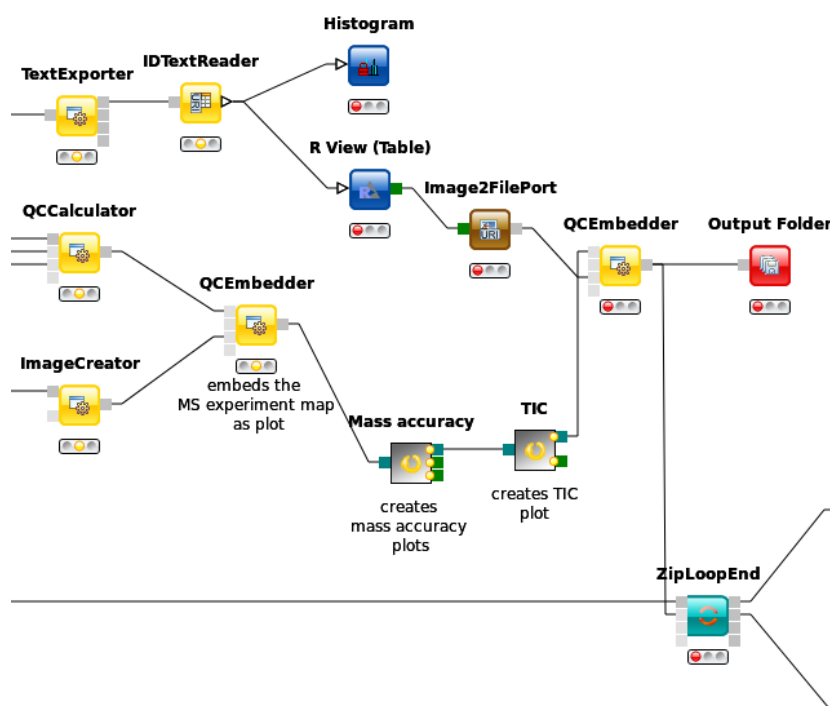

Figure 19: QC with new metric

8.4 Set QC metrics

Besides monitoring the quality of each individual mass spectrometry run analysis, another capability of QC with OpenMS and qcML is to monitor the complete set. The easiest control is to compare mass spectrometry runs which should be similar, e.g. technical replicates, to spot any aberrations in the set.

For this, we will first collect all created qcML files, merge them together and use the qcML onboard *set* QC properties to detect any outliers.

- connect the QCEmbedders output from last section to the ZipLoopEnds second input port.
- The corresponding output port will collect all qcML files from each ZipLoop iteration and pass them on as a list of files.
- Now we add a QCMerger node after the ZipLoopEnd and feed it that list of qcML files. In addition, we set its parameter *setname* to give our newly created set a name - say *spikein_replicates*.
- To inspect all the QCs next to each other in that created qcML file, we have to add a new Output Folder to which we can connect the QCMerger output.

When inspecting the set-qcML file in a **browser**, we will be presented another overview. After the set content listing, the basic QC parameters (like number of identifications) are each displayed in a graph. Each set member (or run) has its own section on the x-axis and each run is connected with that graph via a link in the mouseover on one of the QC parameter values.

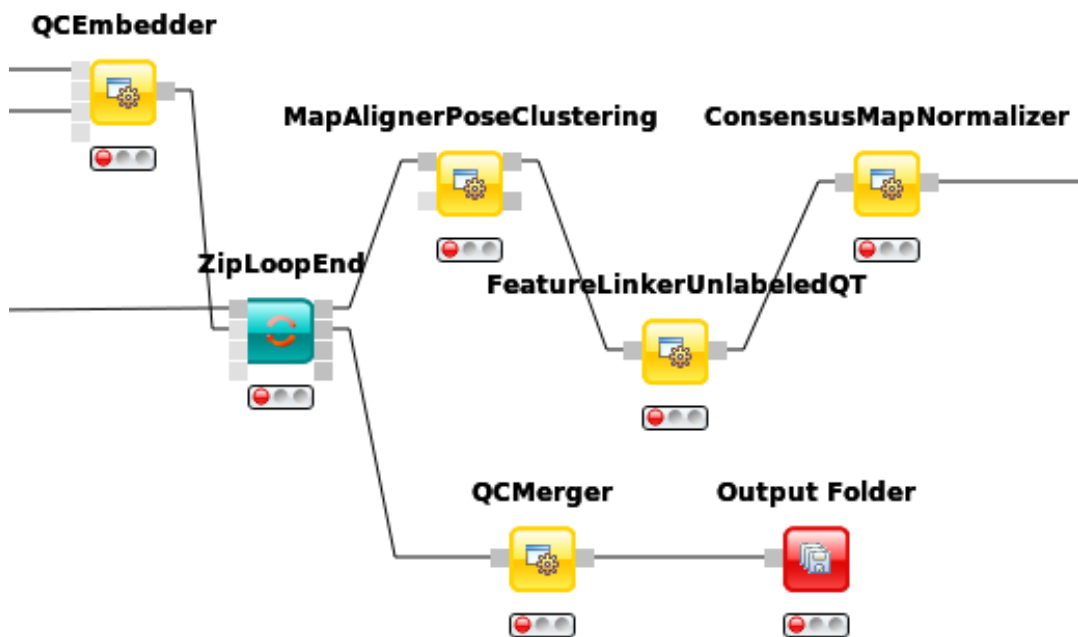

Figure 20: QC set creation from ZipLoop

Task



For ideas on new QC metrics and parameters -as you add them in your qcML files as generic parameters, feel free to contact us, so we can include them in the CV.

9 Troubleshooting guide

This section will show you where you can turn to when you encounter any problems with this tutorial or with our nodes in general. Please see the FAQ first. If your problem is not listed or the proposed solution does not work, feel free to leave us a message at the means of support that you see most fit.

9.1 FAQ

9.1.1 General

Q: Can I add my own modifications to the Unimod.xml?

A: Unfortunately not very easy. This is an open issue.

Q: I have problem XYZ but it also occurs with other nodes or generally in the KNIME environment/GUI, what should I do?

A: This sounds like a general KNIME bug and we advise to search help directly at the KNIME developers. They also provide a FAQ and a forum.

9.1.2 Platform-specific problems

Linux

Q: Whenever I try to execute an OpenMS node I get an error similar to these:

```
/usr/lib/x86_64-linux-gnu/libgomp.so.1: version `GOMP_4.0' not found
/usr/lib/x86_64-linux-gnu/libstdc++.so.6: version `GLIBCXX_3.4.20' not found
```

A: We currently build the binaries shipped in the OpenMS KNIME plugin with gcc 4.8. We will try to extend our support for older compilers. Until then you either need to upgrade your gcc compiler or at least the library that the tool complained about or you need to build the binaries yourself (see OpenMS documentation) and replace them in your KNIME binary folder

(`YOURKNIMEFOLDER/plugins/de.openms.platform.architecture.version/payload/bin`).

Q: Why is my configuration dialog closing right away when I double-click or try to configure it? Or why is my GUI responding so slow?

A: If you have any problems with the KNIME GUI or the opening of dialogues under Linux you might be affected by a GTK bug. See the KNIME forum (e.g. [here](#) or [here](#)) for a discussion and a possible solution.

Windows

Q: KNIME has problems getting the requirements for some of the OpenMS nodes on Windows, what can I do?

A: Get the prerequisites installer [here](#) or install NET3.5, NET4 and VCRedist10.0 yourself.

9.1.3 Nodes

Q: Why is my XTandemAdapter printing empty results?

A: From OpenMS 2.0.1 the XTandemAdapter requires a default parameter file. Give it the default configuration in

```
YOURKNIMEFOLDER/plugins/de.openms.platform.architecture.version/payload/share/  
CHEMISTRY/XTandem_default_input.xml
```

 as a third input file.

Q: Do MSGFPlusAdapter and LuciphorAdapter generally behave different/unexpected?

A: These are Java processes that are started underneath. For example they can not be killed during cancellation of the node. This should not affect its performance, however.

9.2 Sources of support

If your questions could not be answered by the FAQ, please feel free to turn to our developers via one of the following means:

- File an issue on GitHub
- Write to the Mailing List
- Open a thread on the KNIME Community Contributions forum for OpenMS

References

- [1] OpenMS, OpenMS home page [online]. 6
- [2] M. Sturm, A. Bertsch, C. Gröpl, A. Hildebrandt, R. Hussong, E. Lange, N. Pfeifer, O. Schulz-Trieglaff, A. Zerck, K. Reinert, and O. Kohlbacher, OpenMS - an open-source software framework for mass spectrometry., *BMC bioinformatics* **9**(1) (2008), doi:10.1186/1471-2105-9-163. 6, 51
- [3] O. Kohlbacher, K. Reinert, C. Gröpl, E. Lange, N. Pfeifer, O. Schulz-Trieglaff, and M. Sturm, TOPP--the OpenMS proteomics pipeline., *Bioinformatics* **23**(2) (Jan. 2007). 6, 51
- [4] M. R. Berthold, N. Cebron, F. Dill, T. R. Gabriel, T. Kötter, T. Meinel, P. Ohl, C. Sieb, K. Thiel, and B. Wiswedel, KNIME: The Konstanz Information Miner, in *Studies in Classification, Data Analysis, and Knowledge Organization (GfKL 2007)*, Springer, 2007. 6
- [5] M. Sturm and O. Kohlbacher, TOPPView: An Open-Source Viewer for Mass Spectrometry Data, *Journal of proteome research* **8**(7), 3760--3763 (July 2009), doi: 10.1021/pr900171m. 6
- [6] L. Y. Geer, S. P. Markey, J. A. Kowalak, L. Wagner, M. Xu, D. M. Maynard, X. Yang, W. Shi, and S. H. Bryant, Open mass spectrometry search algorithm, *Journal of Proteome Research* **3**(5), 958--964 (2004). 23
- [7] A. Chawade, M. Sandin, J. Teleman, J. Malmström, and F. Levander, Data Processing Has Major Impact on the Outcome of Quantitative Label-Free LC-MS Analysis, *Journal of Proteome Research* **14**(2), 676--687 (2015), PMID: 25407311, arXiv:http://dx.doi.org/10.1021/pr500665j, doi:10.1021/pr500665j. 23
- [8] D. S. Wishart, D. Tzur, C. Knox, et al., HMDB: the Human Metabolome Database, *Nucleic Acids Res* **35**(Database issue), D521--6 (Jan 2007), doi:10.1093/nar/gkl923. 42
- [9] D. S. Wishart, C. Knox, A. C. Guo, et al., HMDB: a knowledgebase for the human metabolome, *Nucleic Acids Res* **37**(Database issue), D603--10 (Jan 2009), doi:10.1093/nar/gkn810. 42

- [10] D. S. Wishart, T. Jewison, A. C. Guo, M. Wilson, C. Knox, et al., HMDB 3.0--The Human Metabolome Database in 2013, *Nucleic Acids Res* **41**(Database issue), D801--7 (Jan 2013), doi:10.1093/nar/gks1065. 42
- [11] J. Griss, A. R. Jones, T. Sachsenberg, M. Walzer, L. Gatto, J. Hartler, G. G. Thallinger, R. M. Salek, C. Steinbeck, N. Neuhauser, J. Cox, S. Neumann, J. Fan, F. Reisinger, Q.-W. Xu, N. Del Toro, Y. Perez-Riverol, F. Ghali, N. Bandeira, I. Xenarios, O. Kohlbacher, J. A. Vizcaino, and H. Hermjakob, The mzTab Data Exchange Format: communicating MS-based proteomics and metabolomics experimental results to a wider audience, *Mol Cell Proteomics* (Jun 2014), doi:10.1074/mcp.0113.036681. 43
- [12] H. L. Röst, G. Rosenberger, P. Navarro, L. Gillet, S. M. Miladinovic, O. T. Schubert, W. Wolski, B. C. Collins, J. Malmstrom, L. Malmström, and R. Aebersold, OpenSWATH enables automated, targeted analysis of data-independent acquisition MS data, *Nature Biotechnology* **32**(3), 219--223 (Mar. 2014). 51, 56
- [13] L. C. Gillet, P. Navarro, S. Tate, H. Röst, N. Selevsek, L. Reiter, R. Bonner, and R. Aebersold, Targeted Data Extraction of the MS/MS Spectra Generated by Data-independent Acquisition: A New Concept for Consistent and Accurate Proteome Analysis., *Molecular & Cellular Proteomics* **11**(6) (June 2012), doi:10.1074/mcp.0111.016717. 51
- [14] A. Bertsch, C. Gröpl, K. Reinert, and O. Kohlbacher, OpenMS and TOPP: open source software for LC-MS data analysis., *Methods in molecular biology* (Clifton, N.J.) **696**, 353--367 (2011), doi:10.1007/978-1-60761-987-1_23. 51
- [15] L. Reiter, O. Rinner, P. Picotti, R. Huttenhain, M. Beck, M.-Y. Brusniak, M. O. Hengartner, and R. Aebersold, mProphet: automated data processing and statistical validation for large-scale SRM experiments, *Nature Methods* **8**(5), 430--435 (May 2011), doi:10.1038/nmeth.1584. 51
- [16] E. W. Deutsch, M. Chambers, S. Neumann, F. Levander, P.-A. Binz, J. Shofstahl, D. S. Campbell, L. Mendoza, D. Ovelleiro, K. Helsens, L. Martens, R. Aebersold, R. L. Moritz, and M.-Y. Brusniak, TraML--A Standard Format for Exchange of Selected Reaction Monitoring Transition Lists, *Molecular & Cellular Proteomics* **11**(4) (Apr. 2012), doi:10.1074/mcp.R111.015040. 52

- [17] C. Escher, L. Reiter, B. MacLean, R. Ossola, F. Herzog, J. Chilton, M. J. MacCoss, and O. Rinner, Using iRT, a normalized retention time for more targeted measurement of peptides., *Proteomics* **12**(8), 1111--1121 (Apr. 2012), doi:10.1002/pmic.201100463.
52